

DOMINO Panel Formwork

Instructions for Assembly and Use – Standard Configuration

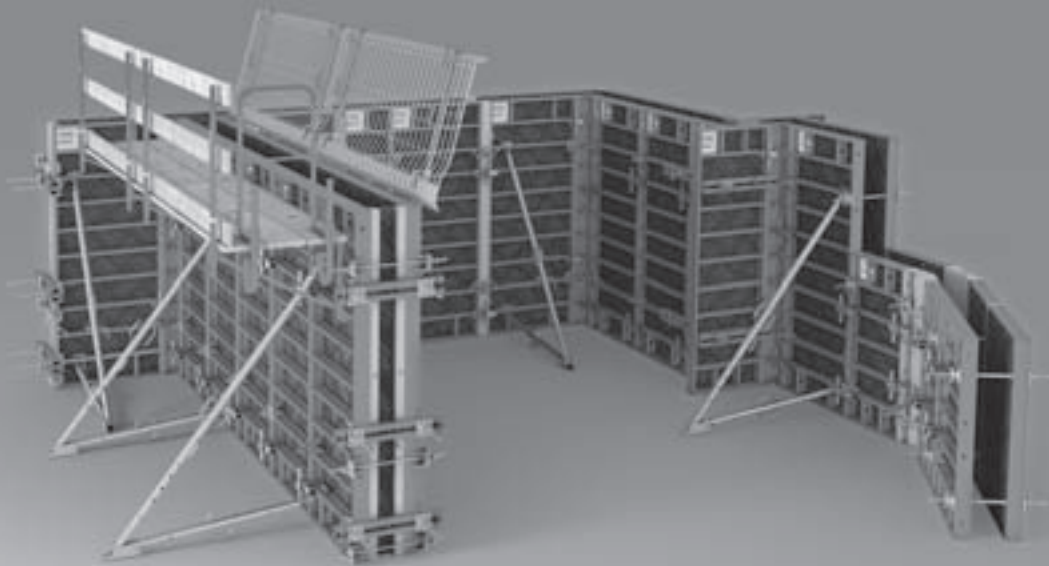

Introduction

Overview, Main Components	1
Key	2
Intended Use	3
Instructions for Use	3
Safety Instructions	4
Additional Technical Documentation	5
Care and Maintenance Instructions	6

Standard configuration up to h = DOMINO 250

A1	Storage and Transportation	7
A2	Quick User Guide	8
A3	DOMINO 250 Panels	10
A4	Panel Connections	
	Alignment Coupler DRS	12
	Wedge Clamp DKS	13
	Compensation Waler DAR 80	13
A5	Tie Point	14
A6	Push-Pull Props, Kicker Braces	15
A7	Corners	
	90° corners	16
	Articulated corners	17
	135° corners	17
A8	T-Junctions	
	90° T-Junction	18
	Wall Connection	19
A9	Wall Offsets	20
A10	Length Compensation	22
A11	Stopend Formwork	
	With timber and filler plywood	23
	With Stopend Panel MT, MTF	24
A12	Working and Concreting Scaffolds	
	Scaffold Bracket DG 85	26
	Guardrails	28
A13	Height Extensions	29
A14	Foundations	30
A15	DOMINO Alu Panels	31

Standard configuration of DOMINO 275

B1	DOMINO 275 Panels	32
B2	Panel Connections	33
	90° Corners	33
B3	Articulated Corners	34
B4	Stopend Formwork	34
	Stopend Panel MTF	35
B5	Height Extensions	36

Standard configuration of DOMINO 300

C1	DOMINO 300 Panels	38
C2	Panel Connections	39
	90° Corners	39
C3	Articulated Corners	40
C4	Stopend Formwork	41
	Height Extensions	41

Components

Components	42
------------	----

Overview

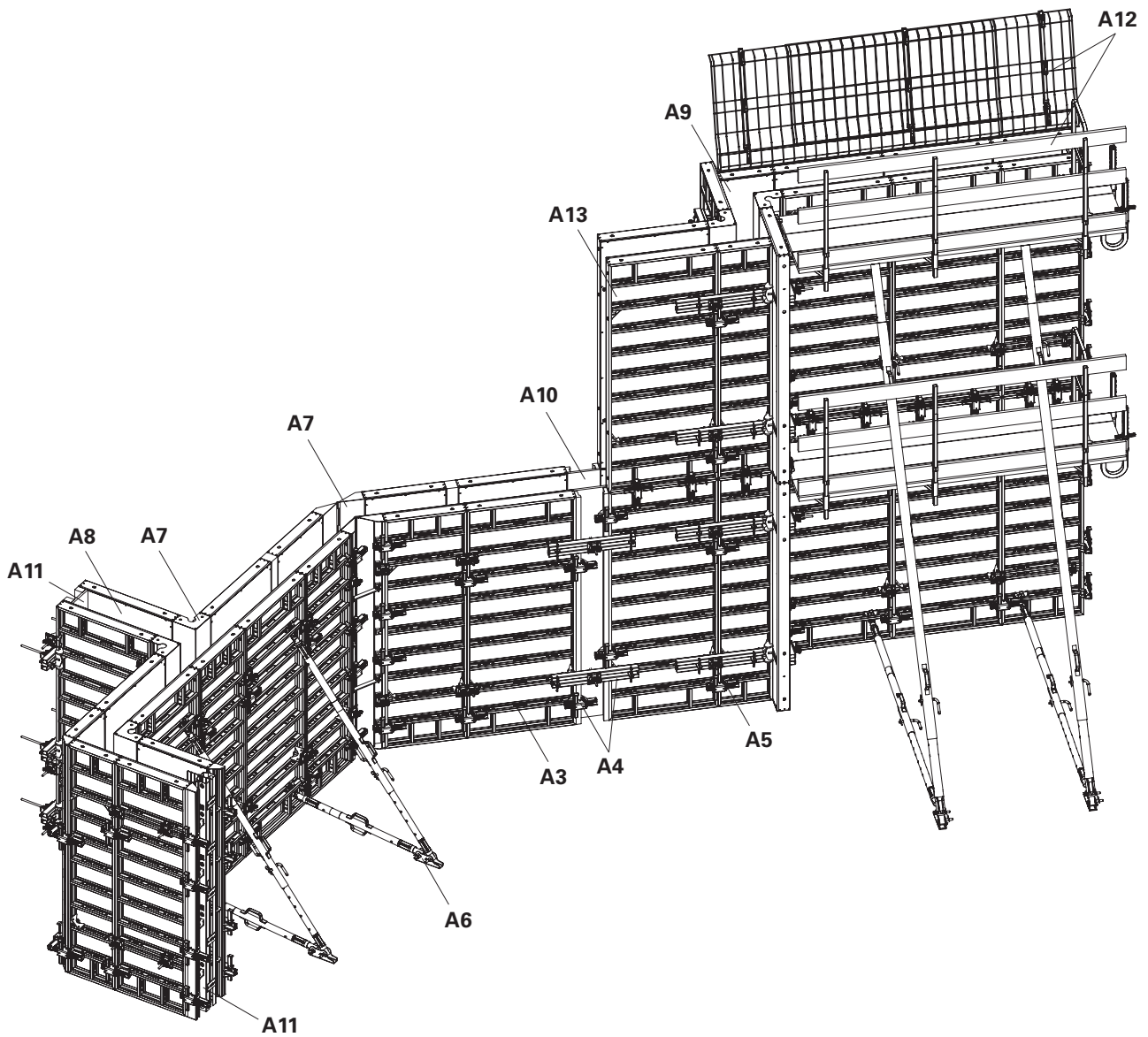

Key

Section

- A3 Panels
- A4 Panel Connections
- A5 Ties
- A6 Push-Pull Props
- A7 Corners
- A8 T-Junctions
- A9 Wall Offsets
- A10 Length Compensation
- A11 Stopend Formwork
- A12 Working and Concreting Scaffolds
- A13 Height Extensions



Safety instructions



Important



Visual check



Tip



Load-bearing point

Dimension specifications

Dimensions are usually given in mm and m. Other measurement units, e.g. cm, are shown in the drawings.

Conventions

– Instructions are numbered (1....., 2.....,....)

Multiple position numbers, i.e. alternative components, are represented with a slash: 1 / 2.

Arrows

Actions



Forces



General

The illustration on the front cover of these instructions is understood to be a system representation only. The assembly steps presented in these Instructions for Assembly and Use are shown in the form of examples with only one component size. They are valid for all component sizes contained in the standard configuration accordingly.

For a better understanding, detailed illustrations are partly incomplete. The safety installations which have possibly not been featured in these detailed drawings must nevertheless be available.

Intended use

Product description

PERI products have been designed for exclusive use in the industrial and commercial sectors only by suitably trained personnel.



The DOMINO wall formwork system consists of lightweight panel formwork for housing and civil engineering (foundations) projects with panels made of steel or aluminium.

The standard configuration includes formwork for vertical walls up to 5.00 m high and wall thicknesses from 20 to 36 cm including push-pull-props and safety equipment.

The basic equipment includes panel, corner and stopend elements as well as length compensations and scaffold brackets. For element connections, the Alignment Coupler or Wedge Clamp as well as the Compensation Waler are used, along with a range of additional parts required to carry out forming.

Due to the integrated tie points, the panels can be used in both a vertical and horizontal position.

Steel components are red powder-coated, aluminium elements are in yellow. System dimensions: see Components.

Technical data	Fresh concrete pressure according to DIN 18218	Evenness according to DIN 18202
DOMINO D 250 Steel		
Hydrostatic pressure	62.5 kN/m ²	Line 7
Constant pressure	60.0 kN/m ²	Line 6
DOMINO 250 Alu		
Pressure flow 	max. 55.0 kN/m ²	Line 6
Constant pressure	50.0 kN/m ²	Line 5
DOMINO D 275 Steel		
Hydrostatic pressure	68.75 kN/m ²	Line 7
Constant pressure	60.0 kN/m ²	Line 6
DOMINO D 275 Alu		
Hydrostatic pressure	68.75 kN/m ²	Line 6
Constant pressure	50.0 kN/m ²	Line 5
DOMINO D 300 Steel		
Pressure flow 	max. 60.0 kN/m ²	Line 7
Constant pressure	60.0 kN/m ²	Line 6

Instructions for Use

General

The use in a way not intended, deviating from the standard configuration or the intended use according to the Instructions for Assembly and Use, represents a misapplication with a potential safety risk, e.g. risk of falling.

Only PERI original components may be used. The use of other products and spare parts is not allowed.

Changes to PERI components are not permitted.

Safety Instructions

General

These Instructions for Assembly and Use serve as basis for the project-related risk assessment and the instructions for the provision and use of the system by the contractor. However, they do not replace them.

The contractor must ensure that the assembly instructions provided by PERI are available at all times for the users and that they are also fully understood. Safety instructions and permissible loads must be observed at all times.

For the application and inspection of our products, the current safety regulations and guidelines in the respective countries where they are being used must be observed at all times.

In order to guarantee the safety against falling, the contractor must carry out a site-specific risk assessment based on these Instructions for Assembly and Use and the included safety and warning information during each respective assembly, modification and dismantling procedure, as well as every time the system is used! Based on the risk assessment, appropriate measures regarding safety against falling are to be implemented on site!

The contractor must ensure that the personal protective equipment required for the assembly, modification or dismantling of the system is available and used as intended.

Materials and working areas are to be inspected on a regular basis especially before each use and assembly, and checked for signs of damage as well as stability and functionality. Damaged components must be exchanged immediately on site and may no longer be used.

The contractor has to provide safe working areas for site personnel which are to be reached through the provision of

safe access ways. Areas of risk must be cordoned off and clearly marked. Safety components are removed only when they are no longer required.

The contractor must guarantee the stability during all stages of construction especially during assembly, modification and dismantling. He must ensure and prove that all loads can be safely transferred.

Deviations from the standard configuration may only be carried out after a separate risk assessment has been completed by the contractor. On this basis, appropriate measures for the working and operational safety as well as the stability are to be implemented. Appropriate proof of stability can be provided by PERI if the risk assessment and measures deriving from this are readily available.

Components provided by the contractor must conform with the characteristics required in these Instructions for Assembly and Use as well as with all valid construction guidelines and standards. In particular, the following applies if nothing else is specified:

- timber components: Strength Class C24 for Solid Wood according to EN 338.
 - scaffold tubes: galvanised steel tubes with minimum dimensions of $\varnothing 48.3 \times 3.2$ mm according to EN 12811-1:2003 4.2.1.2.
- Scaffold tube couplings according to EN 74.

In the event of unfavourable weather conditions, e.g.

- poor visibility (fog),
- strong winds,
- snow,

suitable precautions and measures are to be taken in order to ensure both working and operational safety as well as stability.

In case of extraordinary events which could compromise the safety, e.g.

- storms,
- earthquakes,
- accidents,
- longer downtimes,

the system must be comprehensively checked by a qualified person on behalf of the contractor regarding the working and operational safety as well as the stability. The results of the inspection are to be documented.

Storage and transportation

Store and transport components ensuring that no unintentional change in their position is possible. Detach lifting gear from the lowered components only if they are in a stable position and no unintentional change is possible.

Do not drop the components.

Use only suitable load-carrying equipment to move the components as well as the designated load-bearing points.

During the moving procedure, ensure that components are picked up and set down so that unintentional falling over, falling apart, sliding, falling down or rolling is avoided.

When moving pre-assembled units by crane, always use ropes to guide the load.

The access areas on the jobsite must be free of obstacles and tripping hazards as well as being slip-resistant.

For transportation, the surface must have sufficient load-bearing capacity.

Use original PERI storage and transport systems, e.g. crate pallets, pallets or stacking devices.

Safety Instructions

System-specific

Retract components only when the concrete has sufficiently hardened and the person in charge has given the go-ahead for striking to take place.

Anchoring is to take place only if the anchorage has sufficient concrete strength.

Only use designated PERI lifting gear.

During striking, do not tear off the formwork elements with the crane.

If a storm warning is given, additional push-pull props are to be attached or other bracing measures are to be carried out along with implementing the details contained in the PERI design tables.

Additional Technical Documentation

- DOMINO poster
- DOMINO brochure
- Instructions for Use:
DOMINO Crane Hook,
Pallets and Stacking Devices
- PERI Design Tables
- PERI Rental Service: MAXIMO,
TRIO, DOMINO

Care and Maintenance Instructions

Formwork

Regular cleaning and care is necessary in order to maintain the value and usability of the formwork material over the long-term. Additionally, some repair work may also be inevitable due to the tough working conditions. The following instructions should however help to keep care and maintenance costs as low as possible.

The elements (used or new) should be sprayed all over with the PERI Bio Clean concrete release agent before every use. This makes it easier and quicker to clean the formwork. The concrete release agent should always be sprayed on thinly and evenly!

Spray rear side of the formlining with water immediately after concreting. This saves on time-consuming cleaning operations.

The formlining of the panels must be sprayed with the release agent immediately after striking if in continuous use. Only then cleaning can take place with a scraper, brush or rubber lip scraper. Important: do not clean plywood formlining with a high-pressure cleaner as this can lead to damage.

During cleaning, always ensure that the panels are in a secure position!

Do not clean the elements when suspended from the crane!
Box outs and built-in parts should be

fixed with double-headed nails. This makes it easier to remove the nails later on and to a large extent prevents damage to the formlining.

Any unnecessary anchor holes should be sealed with plugs. As a result, this eliminates subsequent cleaning or repair work. Anchor holes accidentally blocked with concrete are freed by means of a steel pin from the formlining side.

When putting down bundles of reinforcement bars or other heavy objects on horizontally-stored formwork elements, suitable support items, e.g. square timbers, are to be used. This prevents indentations and damage being caused to the formlining.

If possible, concrete internal vibrators are to be used with rubber caps. This reduces the risk of damage to the formlining if accidentally "inserting" the internal vibrator between the reinforcement and formlining.

The panels should not be treated with concrete release agent immediately before transport due to safety reasons.

Steel brushes or hard metal scrapers must not be used for cleaning powder-

coated elements or accessories. Such cleaning processes will destroy the high-quality powder coating.

Use spacers for reinforcement with large-area support or flat supports. This prevents indentations being created in the formlining by the load.

Mechanical components, such as spindles or gear mechanisms, must be cleaned of dirt or concrete residue before and after use, and then greased with suitable lubricants.



Instructions for Use for PERI pallets and stacking devices must always be taken into consideration. Manually-created transportation units must be correctly stacked and secured.

Transport

PERI pallets and stacking devices are suitable for lifting by crane or forklift. They can also be moved with the PERI pallet lifting trolley. All pallets and stacking devices can be lifted using both the longitudinal and front sides.

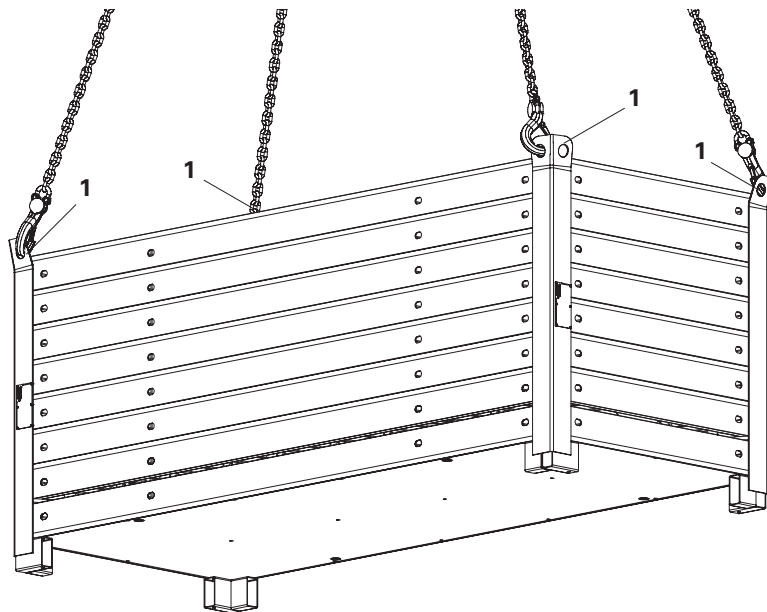

Fig. A1.01

DOMINO Stacking Device



Panels of the same size are to be transported in stacks.
(Fig. A1.01)

Load-bearing capacity:
250 kg/device = 1.0 t/stack.

Number of panels per stack:
2 – 8 DOMINO panels of the same size, for crane and fork-lift transportation.

Crane sling angle $\leq 30^\circ$
4-sling lifting gear L = 3.0 m.

Stacking height:
2 stacks, one on top of each other.

Transport of load



Always attach the 4-sling lifting gear using the four load-bearing points (1).
(Fig. A1.01)

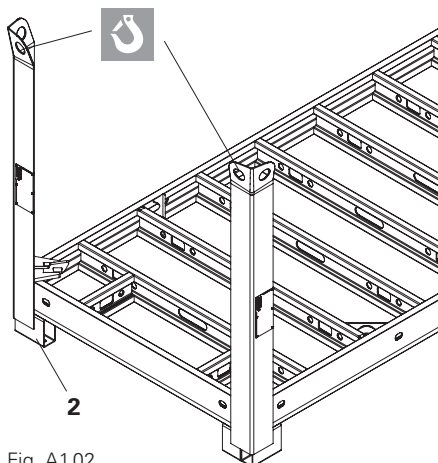

Fig. A1.02

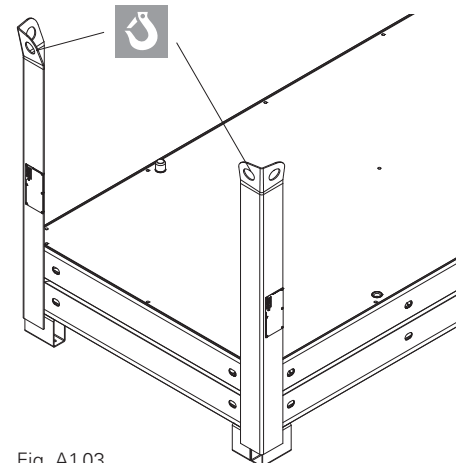

Fig. A1.03

Assembly

1. Place the first panel with the formlining facing downwards on the rectangular tube (2). (Fig. A1.02)
2. Insert the second and additional panels with the formlining facing upwards in the stacking devices. (Fig. A1.03)

Working steps

Primary formwork

1. Assemble horizontally. (Fig. A2.01)
2. Mount Push-Pull Props according to the valid width of influence. (Fig. A2.02)
3. Transport to place of operation by crane. (Fig. A2.03)



**Secure panels against tipping over and wind forces.
Do not release lifting hooks before the Push-Pull Props have been securely fixed in position.**

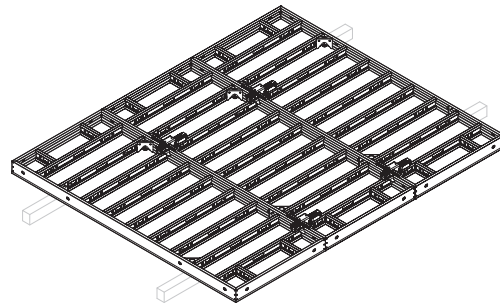

Fig. A2.01

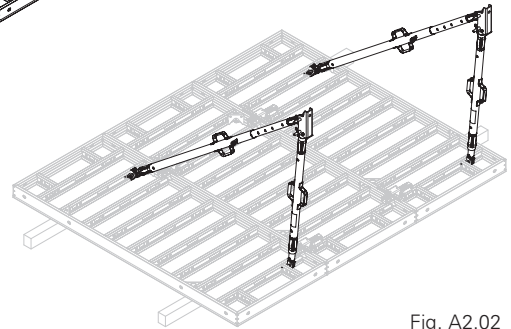

Fig. A2.02

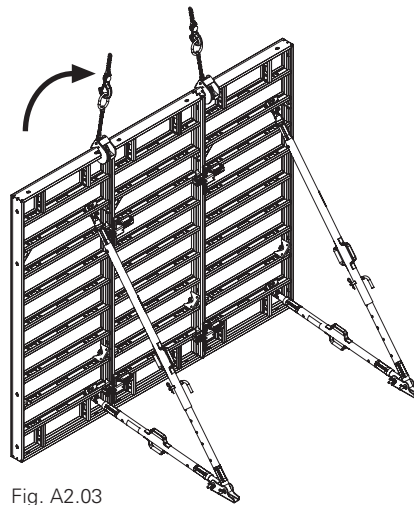

Fig. A2.03

Closing formwork with concreting scaffold

1. Mount brackets to the horizontally-positioned panel. (Fig. A2.04)
2. Install decking and guardrails and then secure in position. (Fig. A2.05)
3. Transport to place of operation by crane.
4. Install anchors.



Release Lifting Hook only after a top anchor has been installed.



Forming from the external or internal corner in the direction of the compensation.

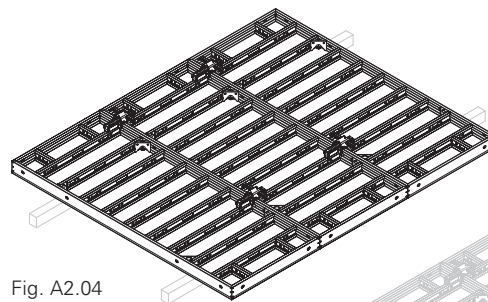

Fig. A2.04

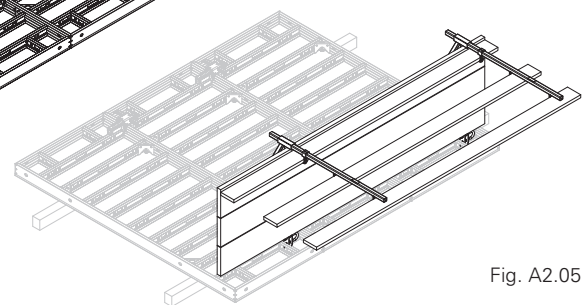
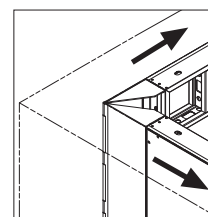
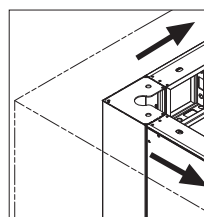
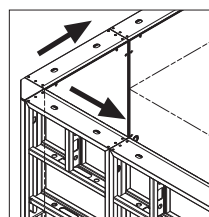

Fig. A2.05

External Corner

Internal Corner with DISE

Internal Corner with DGE



Concreting

from a safe and secure working scaffold.
(Fig. A2.06)

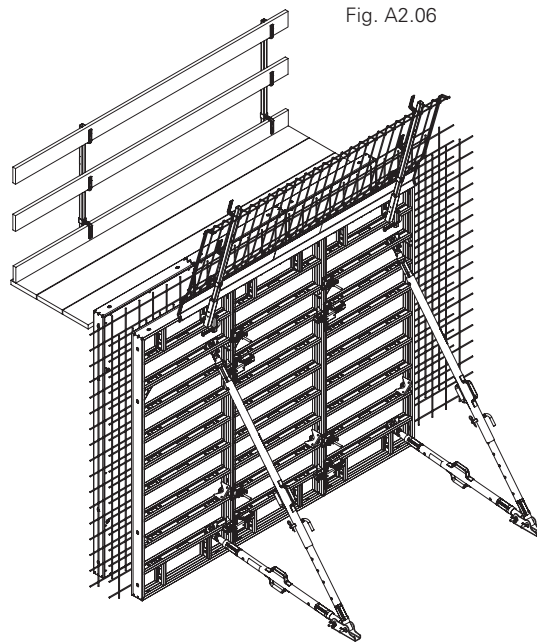

Fig. A2.06

Striking, moving

from the compensation to the corners.



Concrete strength must be taken into account. Secure panels against tipping over and wind forces. Release Lifting Hook only after the Push-Pull Props have been securely fixed in position.

Closing formwork

1. Mount Lifting Hooks and attach to crane. (Fig. A2.07)
2. Remove ties.
3. Release panel connection.
4. Move panel, clean and transport to place of operation by crane.
5. Connect panels, install anchors.
6. Release crane lifting gear.

Primary formwork

1. Mount Lifting Hooks and attach to crane.
2. Release panel connection.
3. Release Push-Pull Prop anchoring.
4. Move panel, clean and transport to place of operation by crane.
5. Connect panels.
6. Fix Push-Pull Props in position.
7. Release crane lifting gear.

Cleaning

with PERI Bio Clean and PERI spraying equipment. (Fig. A2.08)

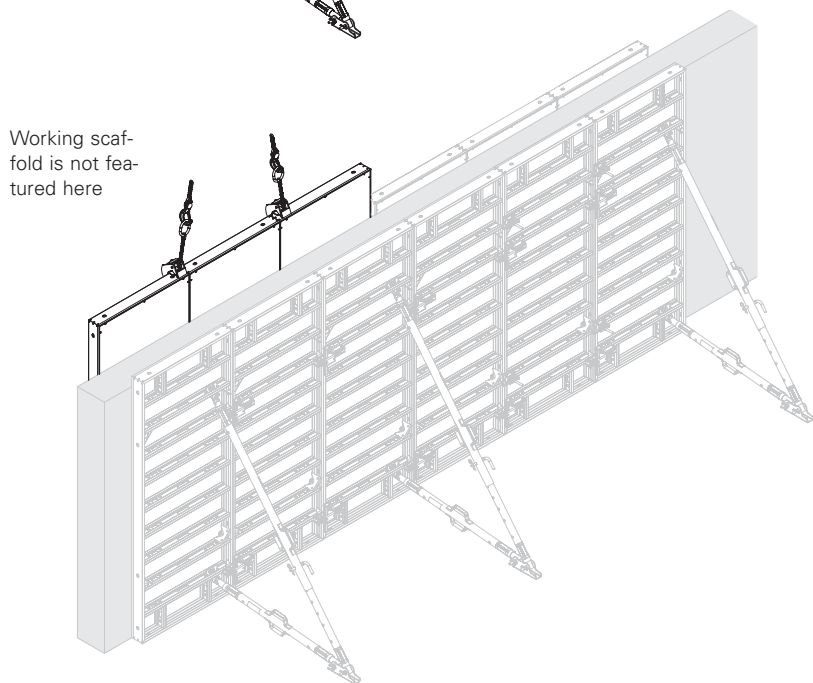

Fig. A2.07

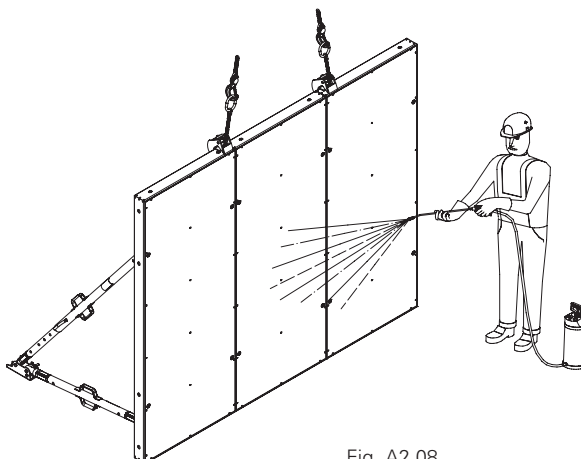
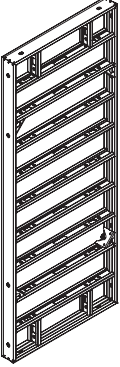
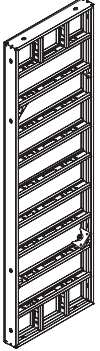
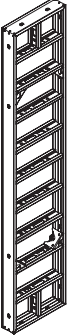

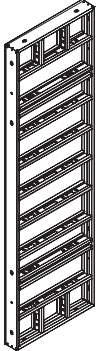
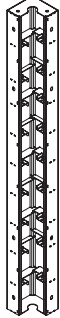





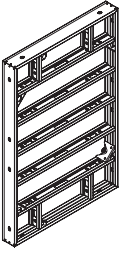
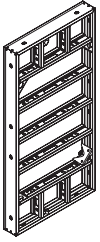



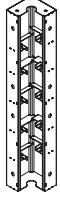





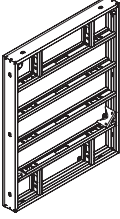
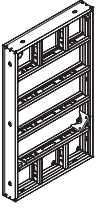



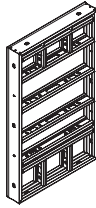
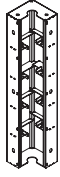





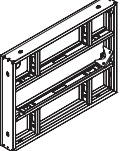
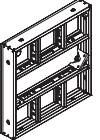



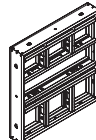





Fig. A2.08

Height Width	100	75	50	35	25	DM 75 Multi-Purpose Panel	DISE Internal Steel Corner	DGE Articulated Corner	DAW Outside Corner Angle	DWD 5 Wall Thickness Compensation	DWD 10 Wall Thickness Compensation	DPA Filler Support
250	 S) A)	 S) A)	 S)	 S)	 S)	 S) A) N)	 S)	 A)	 A)	 A)	 A)	 H)
150	 S)	 S)	 S)	 S)	 S)	 S) N)	 S)	 A)	 A)	 A)	 A)	 H)
125	 S) A)	 S) A)	 S)	 S)	 S)	 S) A) N)	 S)	 A)	 A)	 A)	 A)	 H)
75	 S)	 S)	 S)	 S)	 S)	 S) N)	 S)	 A)	 A)	 A)		

Key

- S) Panels with steel frames
(red powder-coated)
- A) Panels with aluminium frames
(yellow powder-coated)
- N) Standard panels or multi-purpose panels
- H) Timber panels

Panel 250 x 100

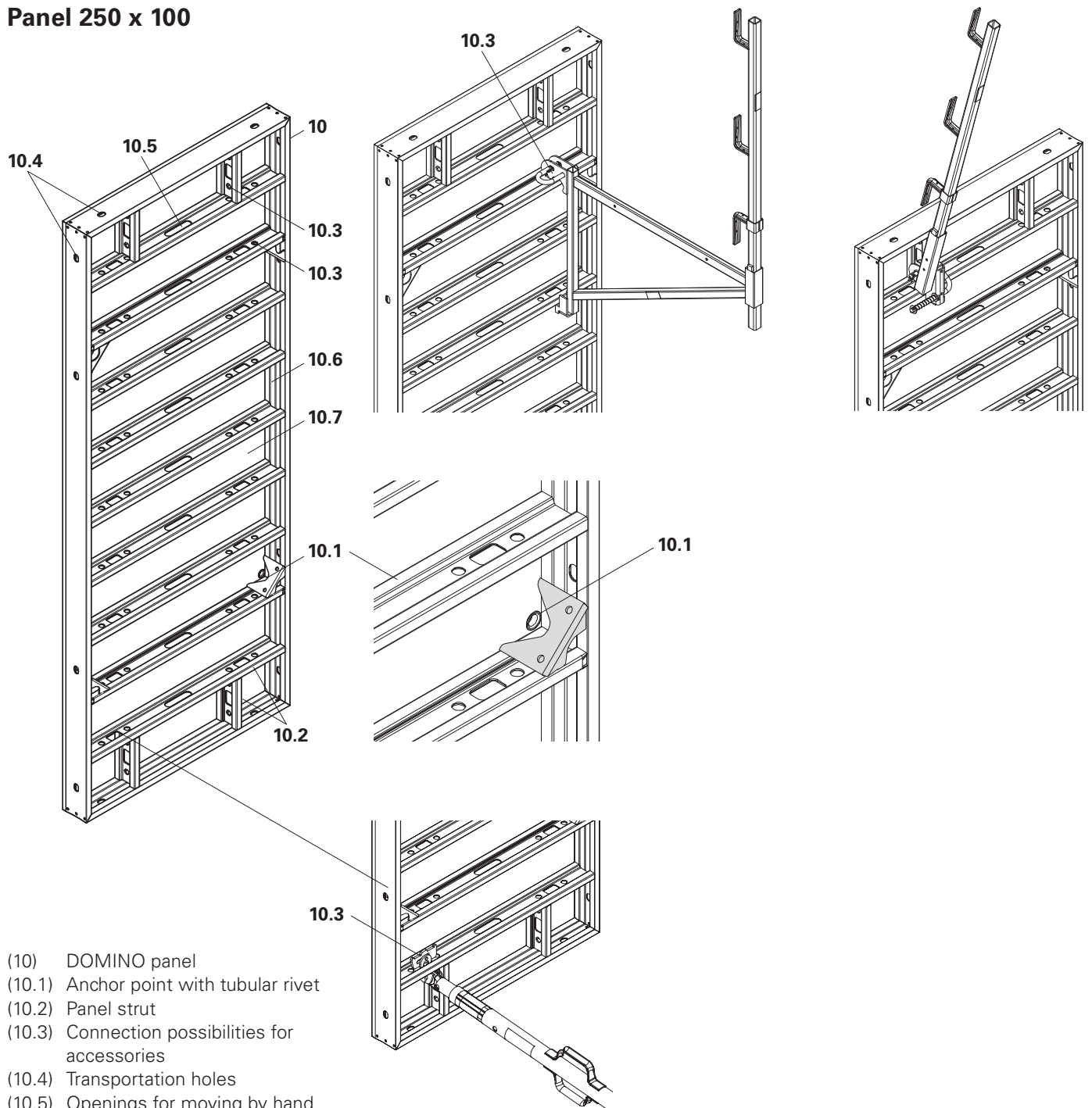

- (10) DOMINO panel
- (10.1) Anchor point with tubular rivet
- (10.2) Panel strut
- (10.3) Connection possibilities for accessories
- (10.4) Transportation holes
- (10.5) Openings for moving by hand
- (10.6) Frame
- (10.7) Plywood

Alignment Coupler DRS

Areas of use:

- standard joints
- external corners, internal corners
- obtuse and acute-angled corners
- stopend formwork
- filler timber
- extensions

Quantity

2 x Alignment Coupler DRS (20) for standard joints.
(Fig. A4.01)

Assembly

1. Place wedge (20.1) in upper end position.
2. Open sliding part (20.2). (Fig. A4.02)
3. Attach Alignment Coupler (20) to panel strut (10.2).
4. Close sliding part. Continuous adjustment possible due to wedge spline (20.3)
5. Secure wedge. (Fig. A4.03) The Alignment Coupler is now securely in position.

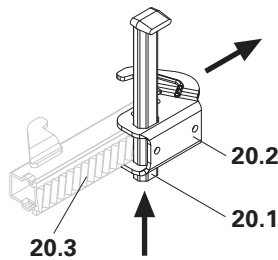
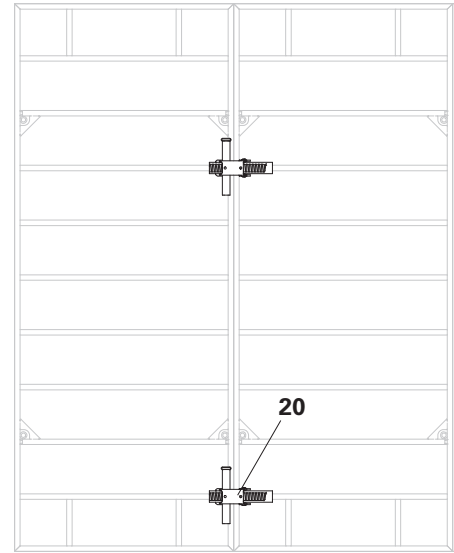
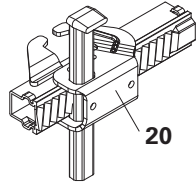

Fig. A4.02

Fig. A4.01



If the wedge head (20.4) is up against the sliding part, there is no clamping effect!
If so, release the wedge, re-position the sliding part and secure again with the hammer.



When securing the wedge, the following effects occur due to the angle of the frame profile:

1. Panels are flush.
 2. Panels are aligned.
 3. Panels are tightly connected.
- (Fig. A4.03.1)

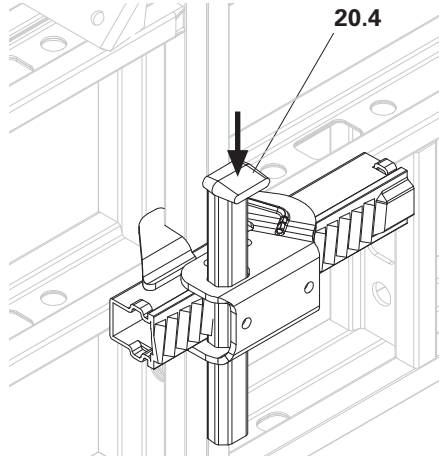

Fig. A4.03

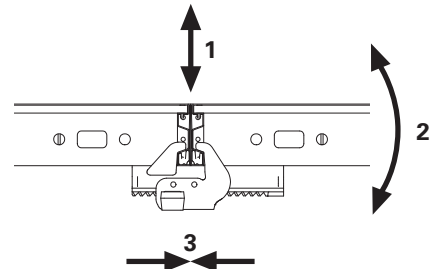

Fig. A4.03.1

Wedge Clamp DKS

For the standard panel joint in the foundations.
(Fig. A4.04)

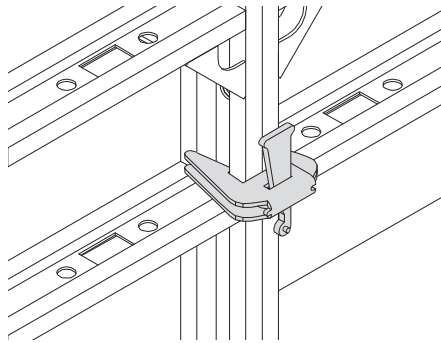

Fig. A4.04

Compensation Waler DAR 80

The Compensation Waler DAR 80 (21) is used to brace and align panel connections as well as for transferring forces.

Areas of use:

- length compensation
- corners with double Wall Thickness Compensator WDA
- acute and obtuse-angled corners
- wall offsets
- stopend formwork
- extensions at great heights

Assembly

1. Insert the hooks of the bracket into the connecting holes (10.3) of the panel.
2. Securely fix the wedges.
(Fig. A4.05)

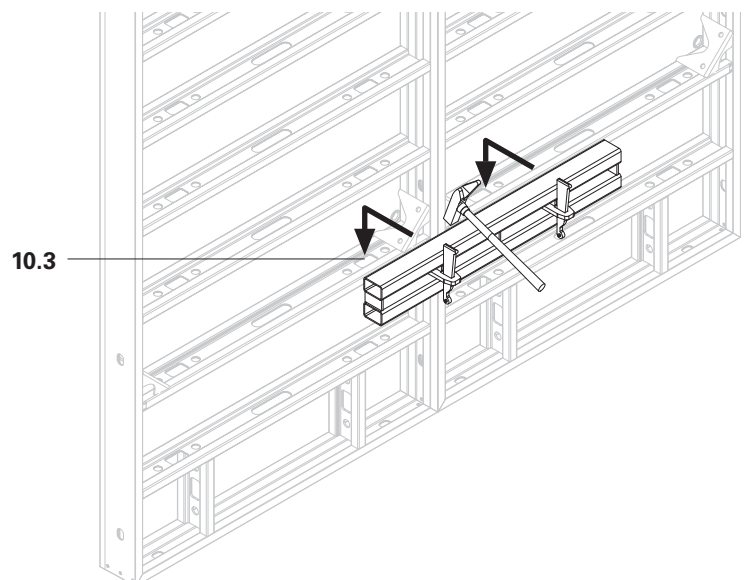
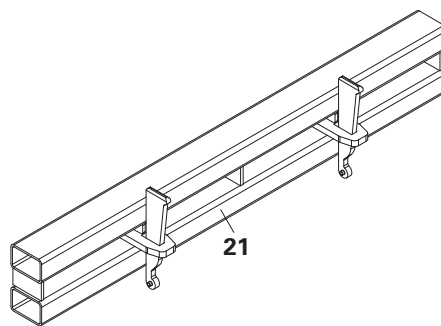

Fig. A4.05

Anchor System DW 15

Permissible load of the tie rod according to DIN 18216 is 90 kN.

Required components

30	Tie Rod	1x
31	Spacer Tube	1x
32	Cone	2x
33	Wingnut Pivot Plate	2x

(Fig. A5.01)

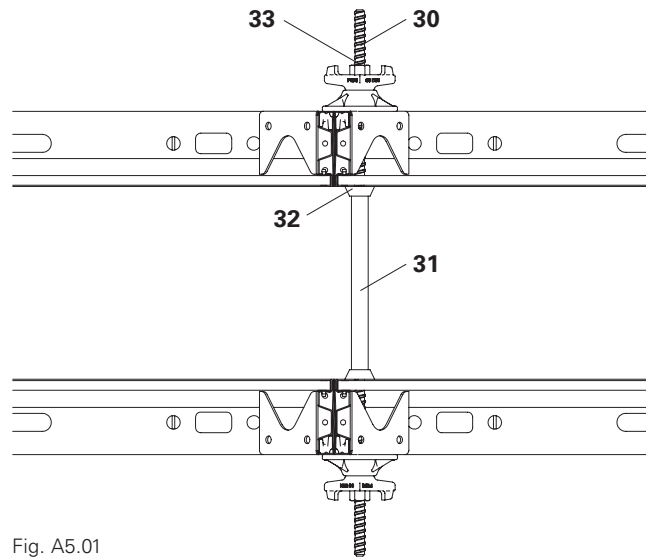

Fig. A5.01

Miscellaneous

- Tie Rod Wrench (34) for one-man anchor point operations from one side
- Plug (35) for sealing tie holes which are not required

(Fig. A5.02)

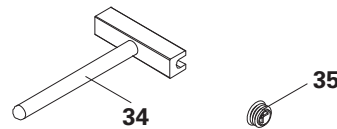

Fig. A5.02



Application

- Only use as many ties as are required
- Close unneeded tie points with plugs
- Do not exceed permissible tie loads
- Maintain permissible fresh concrete pressure
- When using Articulated Corners as 90° internal corners, only the outer holes may be used for anchoring if using Wingnut Pivot Plates (Fig. A5.03)
- When using Compensation Walers, e.g. for oblique angles, anchoring can take place through both holes (Fig. A5.03)

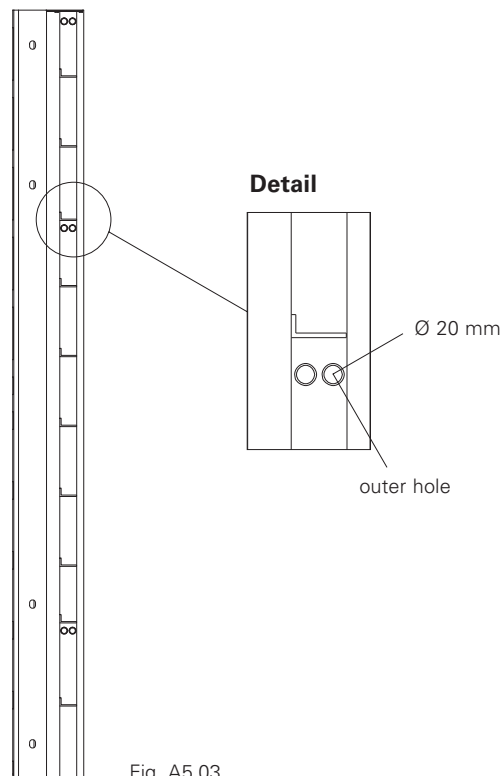

Fig. A5.03

Brace Connector DRA

Assembly

Push-Pull Props and Kickers are attached to the panels by means of the Push-Pull Prop Connector DRA (41). The connection is only possible on horizontal panel struts. (Fig. A6.01)

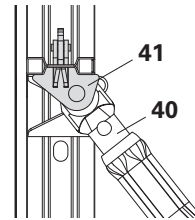
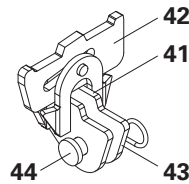

Fig. A6.01

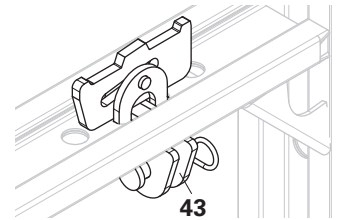

Fig. A6.02

1. Place the Wedge Closing Device (42) in a vertical position.
2. Insert the Push-Pull Prop Connector from below through the connecting hole.
3. Turn the Wedge Closing Device to a horizontal position and secure.

Push-Pull Props and Kickers

1. Attach Push-Pull Prop (40) or Kicker to the connecting plate (43) using Pins and Cotter Pins (44). (Fig. A6.02)
2. Mount Base Plate, e.g. with PERI Anchor Bolts 14/20 x 130 or similar (45). (Fig. A6.03)

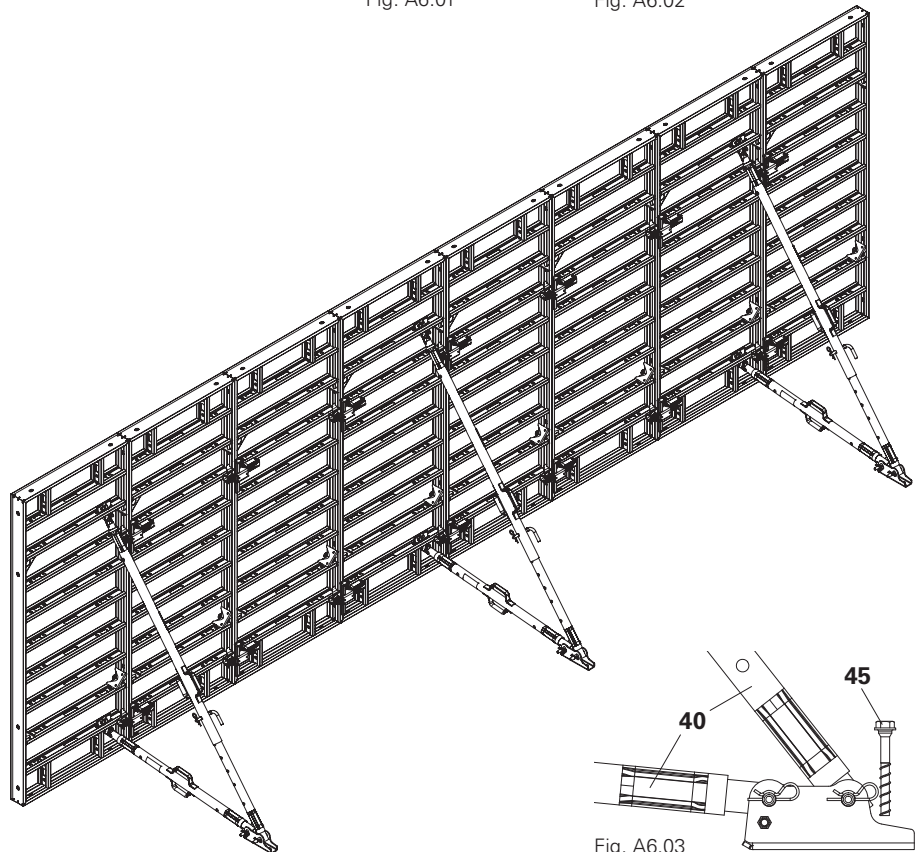

Fig. A6.03

Table for PERI Push-Pull Props and Kickers

		Formwork height h [m]					
		1.50	2.50	2.75	3.00	4.00	5.00
Permissible width of influence [m]	EB_{ref}	3.60	2.91	2.34	1.92	1.43	1.14
actual Push-Pull Prop load [kN]	F_{RS}	5.00	5.00	5.00	5.00	5.00	5.00
actual Kicker load [kN]	F_{AV}		2.00	1.50	1.10	1.10	1.10
Base Plate	resulting force [kN]	5.00	6.60	6.20	5.80	5.90	5.90
	resulting angle of attack [°]	60	47	50	53	52	52
x = Distance of Base Plate from rear edge of formwork [m]	x	0.60	1.20	1.20	1.20	1.60	2.00
y = *Top connection point from top of formwork [m]	y	0.50	0.50	0.75	1.00	1.25	1.50

Note:

Protection against lifting is to be provided if $1.5 \times V_{\text{Wind}} - 0.9 \times G \times h > 0$

*If necessary, the distances must be adapted to the existing system measurement of the formwork system.

Load assumptions:

- Formwork in vertical position on ground
- Wind loads according to DIN 1055-4:2005-03
 $w = q(z) \cdot c_p \cdot \kappa$ [kN/m²]
- Inland, Wind Load Zone 2
- Peak velocity pressure $q(z) = 0.59$
- Assumed aerodynamic coefficient $c_p = 1.8$
- Service life factor $\kappa = 0.6$
- Inclination of the Push-Pull Props to the horizontal 60°
- Values are characteristic values
- With deviating boundary conditions, PERI design tables should be taken into account and the permissible width of influence (WI) is to be adjusted accordingly: $WI = WI_{\text{ref}} \times w_{\text{ref}}/w$

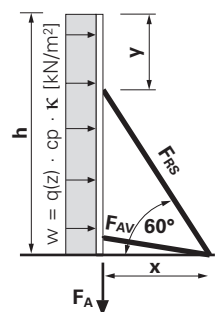

Lifting forces to be anchored $F_{A,d} = 1.5 \times V_{\text{Wind}} - G \times h$ with $G =$ weight per unit area of the formwork including platforms.

90° corners

Wall thicknesses from 20 cm to 36.5 cm can be continuously formed.
(Fig. A7.01)



- Wall thickness 25 cm without any adjustment
- for wall thicknesses < 25 cm adjustment internal
- for wall thicknesses > 25 cm adjustment external

Adjustments are carried out by means of the Wall Thickness Compensator DWD 5 (18) or with timber provided by the contractor (50).

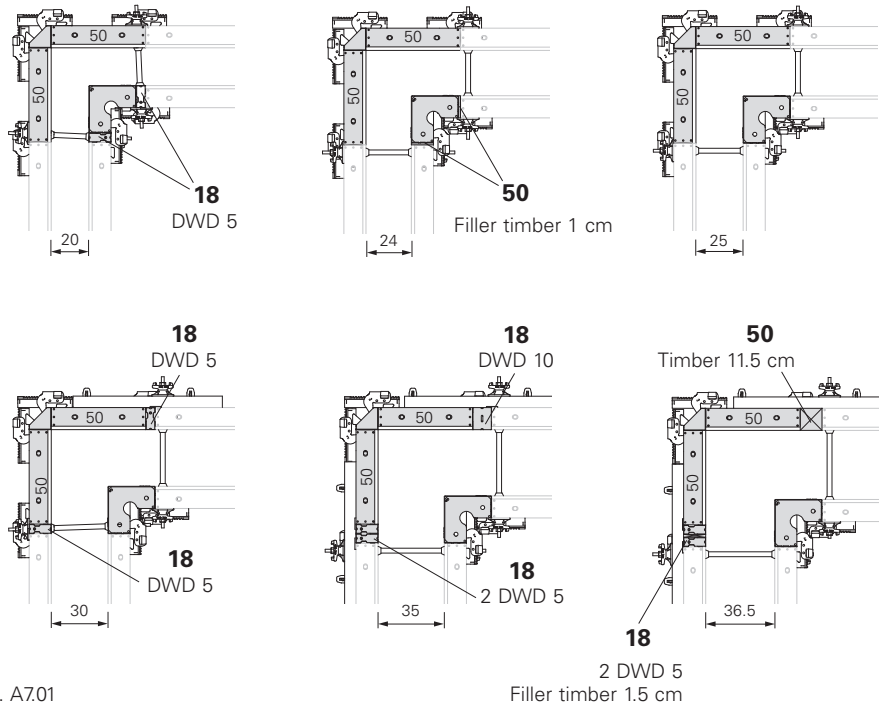

Fig. A7.01

External corner

Required components

11	Element ... x 50	2x
12	External Corner DAW	1x
20	Alignment Coupler DRS per side	2x

(Fig. A7.02)



Firstly, install the right Alignment Coupler DRS and then the left one. Mounting the other way round is not possible.

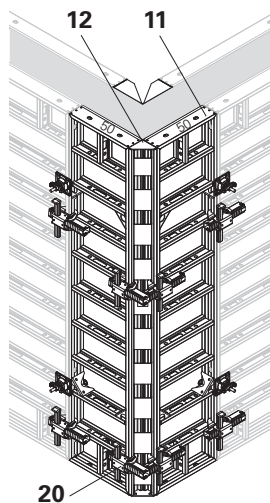

Fig. A7.02

Internal corner

Required components

13a	Inside Steel Corner DISE	1x
20	Alignment Coupler DRS	2x

(Fig. A7.03a)

Alternatively:
Articulated Corner DGE (13b) with
2 x Corner Locking 90° (13.1).
(Fig. A7.03b)

For the number of Alignment Couplers required for other panel heights:
see DOMINO poster.

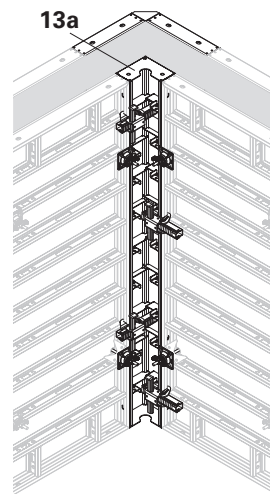

Fig. A7.03a

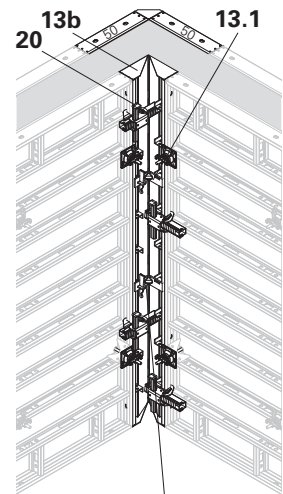
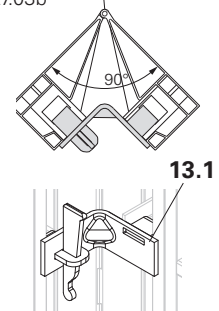

Fig. A7.03b



Articulated corners

For oblique angles of 75° and more.
(Fig. A7.04)



DRS Alignment Couplers are to be installed in a bottom to top direction for both external and internal corners.

For the number of Alignment Couplers required for other panel heights: see DOMINO poster.

External corner

Required components

20	Alignment Coupler DRS	5x
21	Compensation Waler DAR 80	2x

(Fig. A7.04)

Internal corner

Required components

20	Alignment Coupler DRS	4x
-----------	-----------------------	----

(Fig. A7.06)

135° corners

For 135° corners, the Positioning Pin 135° (13.1) is used on both the inside and outside.

(Fig. A7.05)

Assembly of the locking device

1. Remove Corner Locking 90°.
2. Install Positioning Pin 135° with bolts.

Filler areas (x)

Angle	Wall thickness [cm]				
	20	25	30	35	36
165°	2.7	3.4	4.1	4.7	4.8
150°	5.6	6.9	8.3	9.6	9.9
135°	8.6	10.7	12.8	14.8	15.2
120°	12	14.9	17.8	20.7	21.2
105°	16	19.8	23.6	27.5	28.2
75°	27.1	33.6	40.1	46.7	48

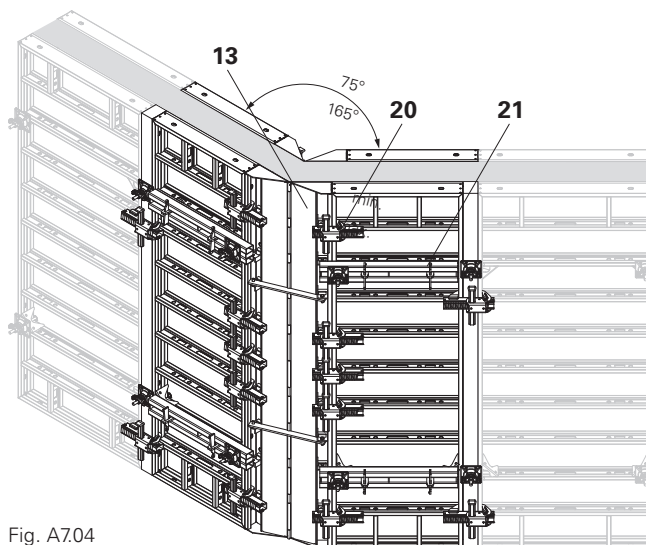

Fig. A7.04

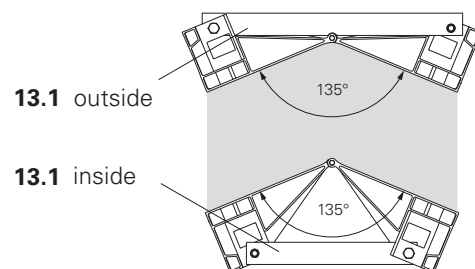

Fig. A7.05

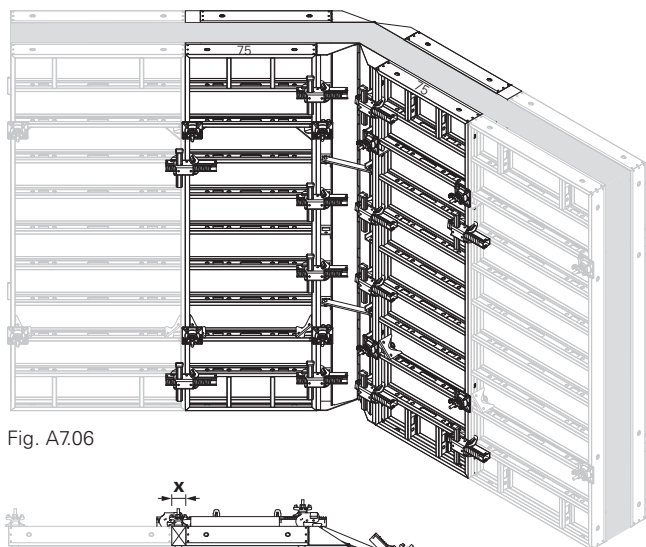
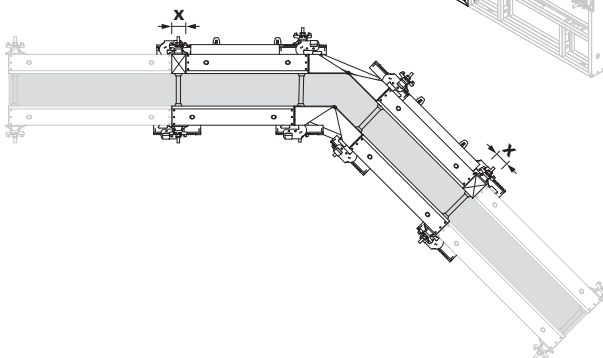

Fig. A7.06



90° T-Junction

Wall thicknesses from 15 cm to 35 cm can be continuously formed. (Fig. A8.01)



- Wall thickness 25 cm without any adjustment
- Wall thicknesses < 25 cm adjustment internal
- Wall thicknesses > 25 cm adjustment external

Adjustments are carried out by means of the Wall Thickness Compensator DWD 5 (18) or with timber provided by the contractor (50).

Assembly

- Form the T-Junction with the Internal Steel Corner DISE (13a)
- Form the straight wall section on the opposite side with Panel D 75 (15)



If two Compensators (DWD) are required: install one DWD right and one left of the Panel D 75.

Alternatively:
Articulated Corner DGE with 2 x Corner Locking 90°.

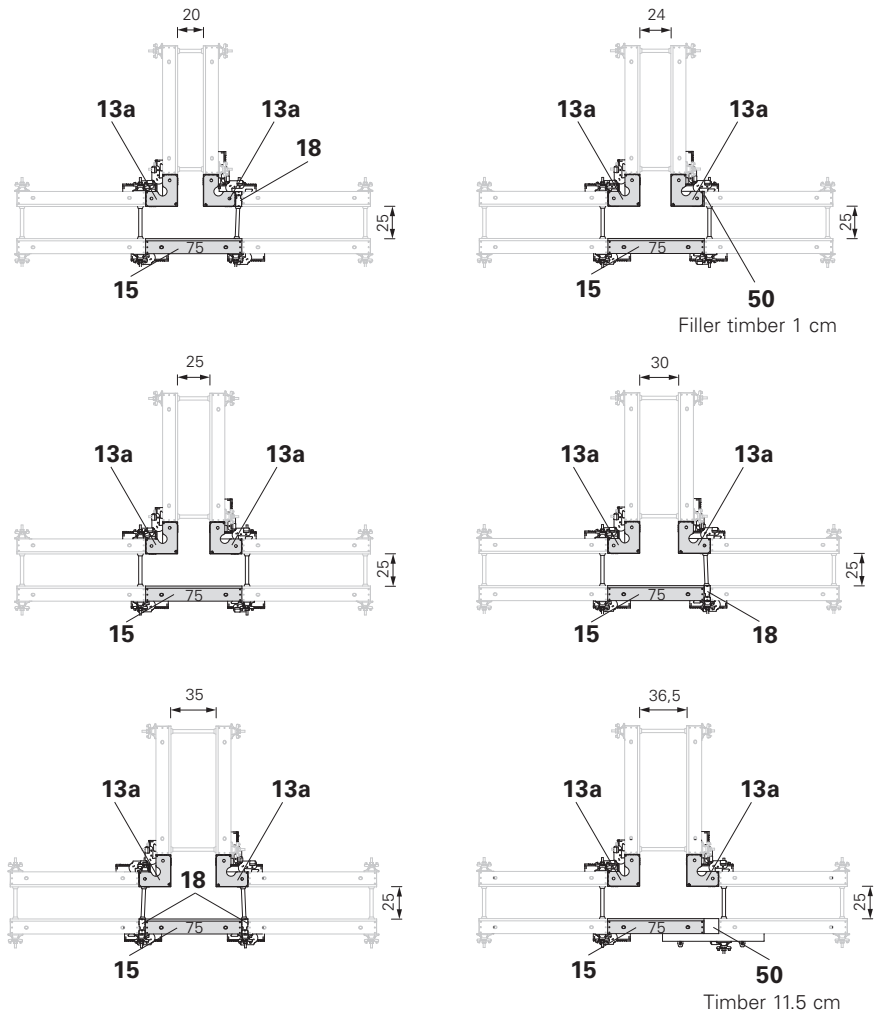

Fig. A8.01

Pilaster

For the arrangement and number of the horizontal Compensation Walers DAR 80 (24) and Frame Spanner (55): see Stop-end Formwork with Timber. (Fig. A8.02)

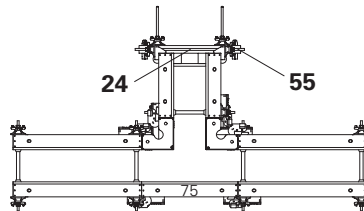

Fig. A8.02

Obtuse-angle wall connection

With DOMINO Panel and Cam Nut DW 15 (19).

(Fig. A8.03)

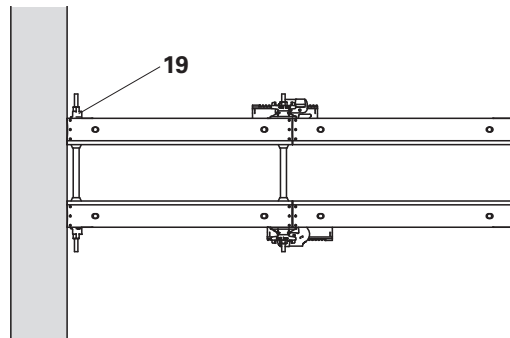

Fig. A8.03

With Multi-Purpose Panel DM ... x 75.

(Fig. A8.04)

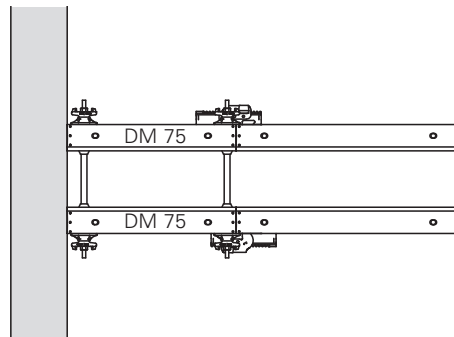

Fig. A8.04

With Wall Thickness Compensator DWD (18) or timber supplied by contractor.

(Fig. A8.05)

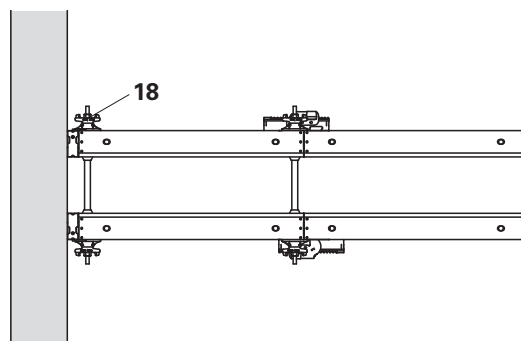

Fig. A8.05

Wall offset ≤ 17 cm

By moving the panel laterally.

Required components for one side

21	Compensation Waler DAR 80	2x
29	Hook Tie DW 15/400	2x
50	Compensation provided by contractor	2x
51	Plywood filler at the front	1x
20	Additional Alignment Coupler DRS for wall offsets of 12 cm and more	1x

(Fig. A9.01)

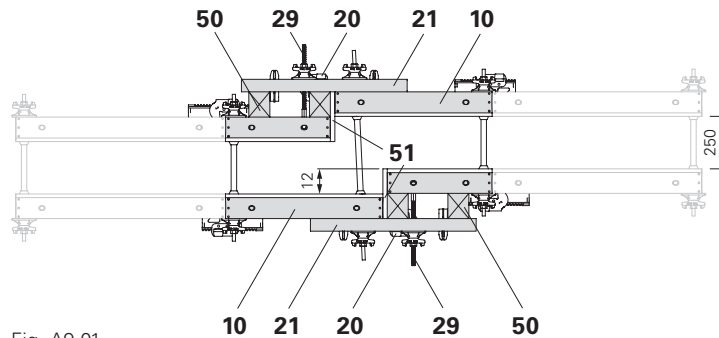

Fig. A9.01

Wall offset 17 – 83 cm

Required components for one side

10	Multi-Purpose Panel DM 75	1x
13a	Inside Steel Corner DISE	1x
21	Compensation Waler DAR 80	2x
25	Stopend Tie DSA	2x

(Fig. A9.02)

Alternatively:

Articulated Corner DGE with 2 x Corner Locking 90°.

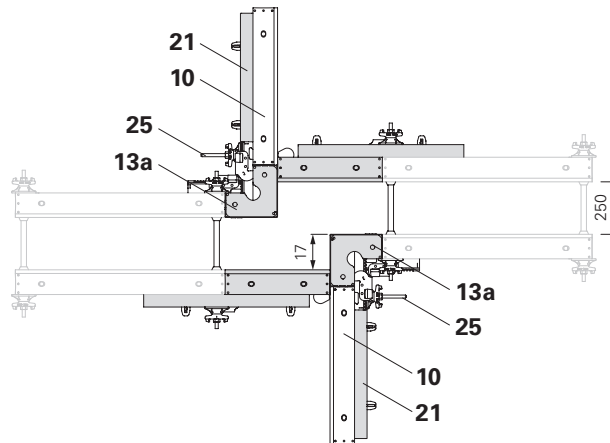

Fig. A9.02

Wall offset 25 – 37 cm

Required components for one side

13a	Inside Steel Corner DISE	1x
12	External Corner DAW	1x
21	Compensation Waler DAR 80	2x
50	Compensation ≤ 12 cm provided by the contractor	1x

(Fig. A9.03)

Alternatively:

Articulated Corner DGE with 2 x Corner Locking 90°.

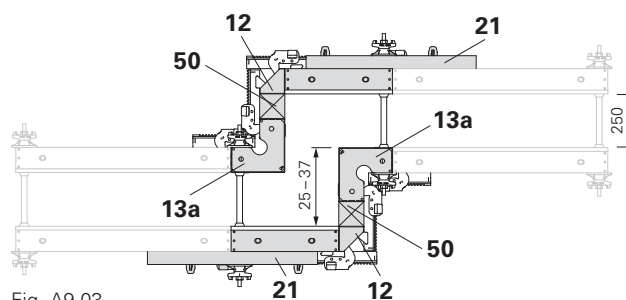

Fig. A9.03



Locating board facilitates the positioning of the formwork panel.

Height offsets

For height offsets: depending on the offset itself, Alignment Couplers DRS (20) are installed alternately on the frame struts of the right and left panels. (Fig. A9.04)

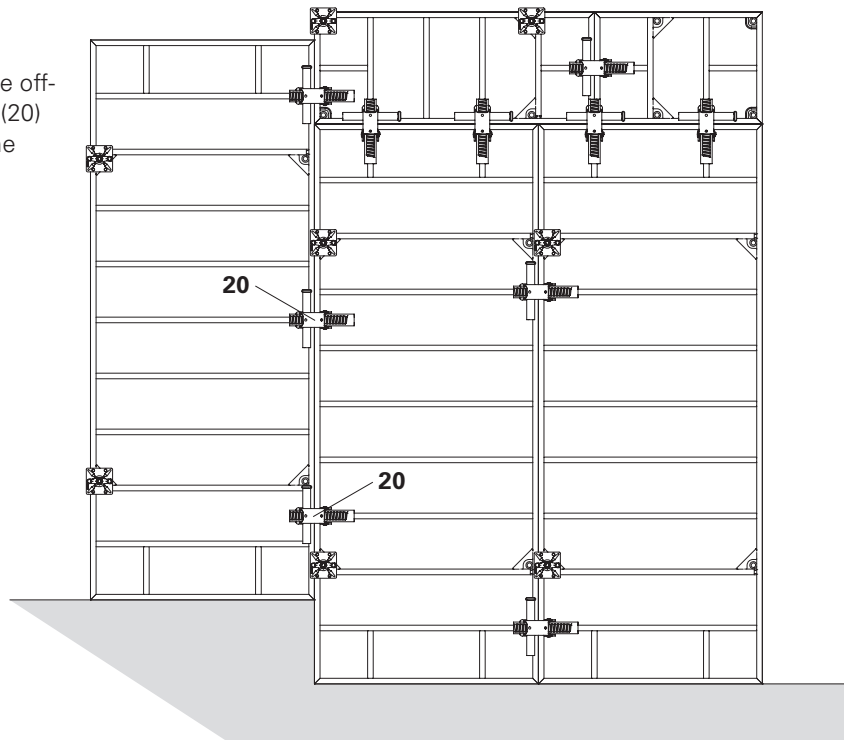

Fig. A9.04

With timber ≤ 12 cm provided by the contractor

Length compensation takes place using cut-to-size timber (50).



- Timber ≤ 10 cm with Alignment Coupler DRS (20) (Fig. A10.01a)
- Timber ≤ 12 cm with Alignment Coupler DRS and Compensation Waler DAR 80 (21) (Fig. A10.01b)
- With compensations > 2.5 cm, anchoring in middle of timber
- Arrange Alignment Couplers DRS (20) as for standard panel joints
- The Wingnut Pivot Plate DW 15 must overlap the frame of the adjoining panel by at least 1 cm (with timber ≤ 10 cm)

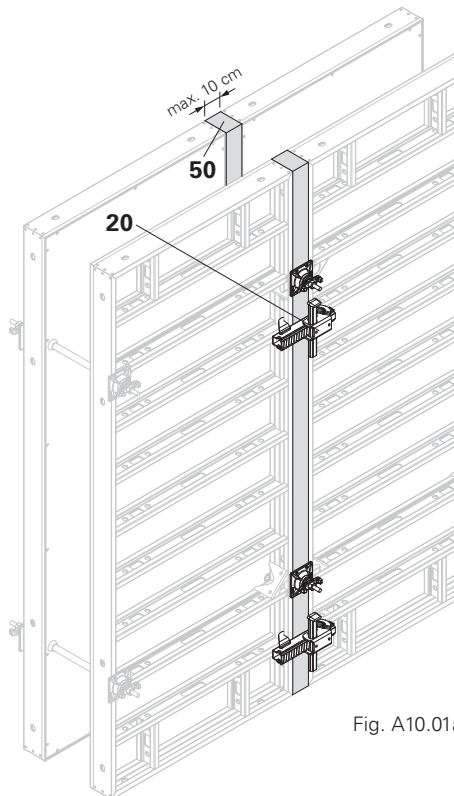

Fig. A10.01a

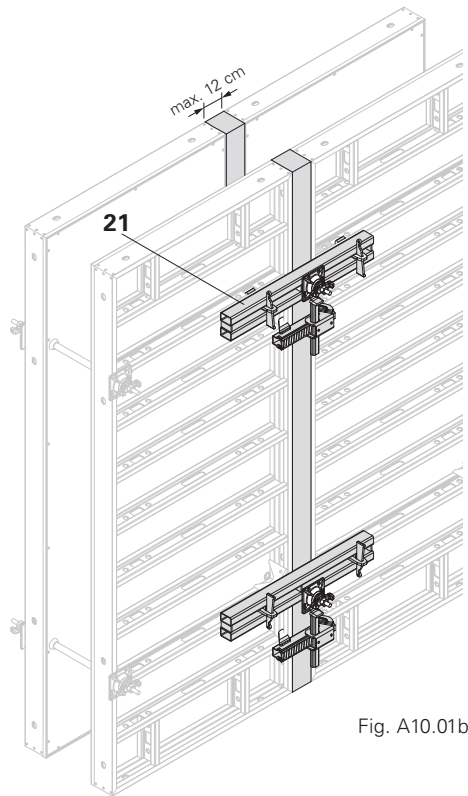

Fig. A10.01b

With Filler Support DPA for compensations up to 30 cm

Required components

53	Filler Support DPA	2x
51	Plywood filler 21 mm	1x

(Fig. A10.02)



Anchoring must be carried out in a way that anchor forces are transferred through the centre of the PERI Compensation Waler DAR 80 (21) to the adjacent panels.

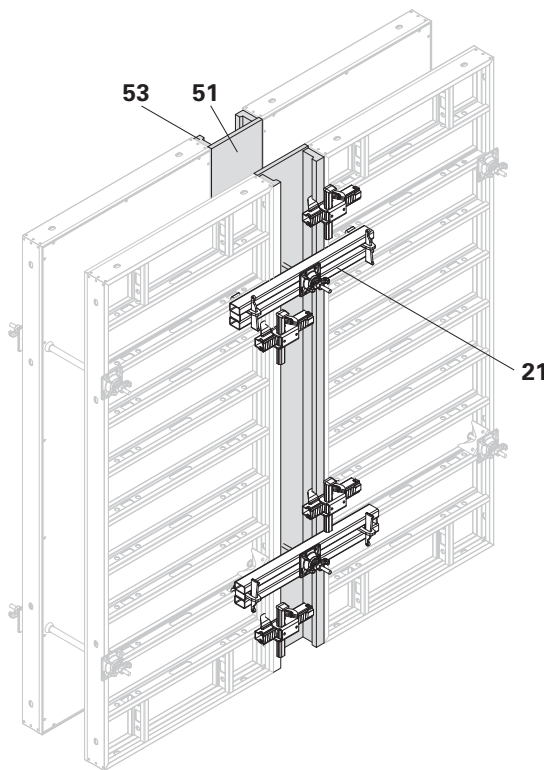
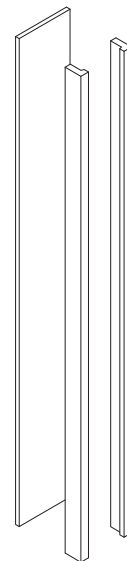
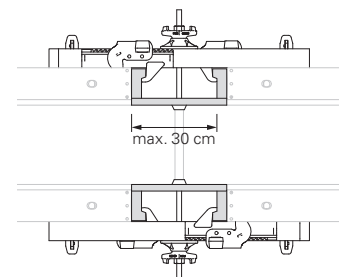

Fig. A10.02



With timber and filler plywood

For wall thicknesses up to 36.5 cm.

Height 250

Required components

21	Compensation Waler DAR 80	3x
25	Stopend Tie DSA	6x
33	Wingnut Pivot Plate	6x
55	Top Tie Bracket DAH with tie set	6x

(Fig. A11.01a)

The fresh concrete pressure from the Stopend Formwork is transferred by means of the Stopend Ties and Compensation Walers DAR 80 to the DOMINO panels.

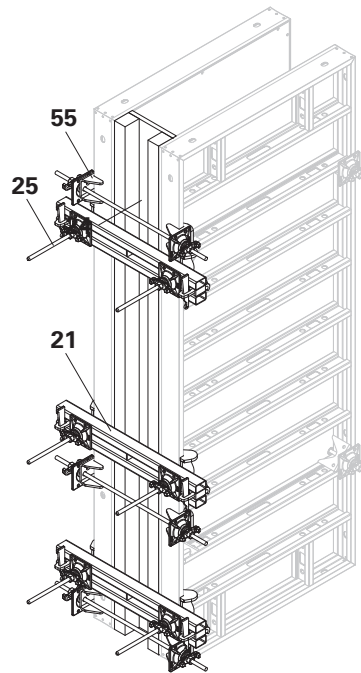
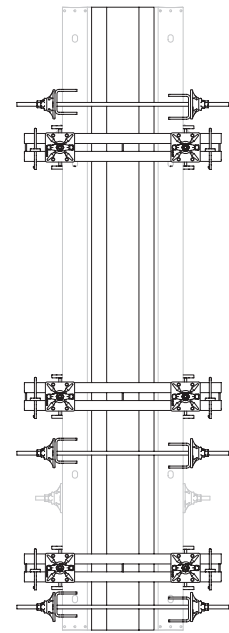

Fig. A11.01a



Height 150

Required components

21	Compensation Waler DAR 80	2x
25	Stopend Tie DSA	4x
33	Wingnut Pivot Plate	4x
55	Top Tie Bracket DAH with tie set	4x

(Fig. A11.01b)

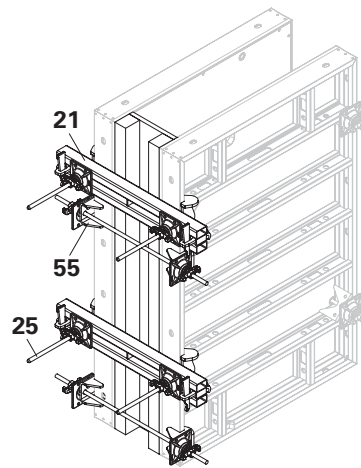
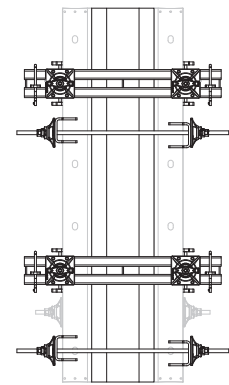

Fig. A11.01b



Stopend panel reinforcement with and without water bar

Up to h = 2.50 m.

Required components

56	Außenteil AT 3	2x
	Betondeckung ca. 2,5 cm	
56	Außenteil AT 5	2x
	Betondeckung ca. 5 cm	
57	Mittelteil MTF	1x

(Fig. A11.02)

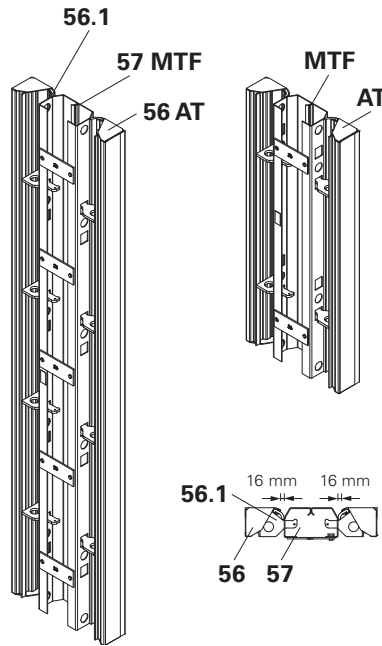
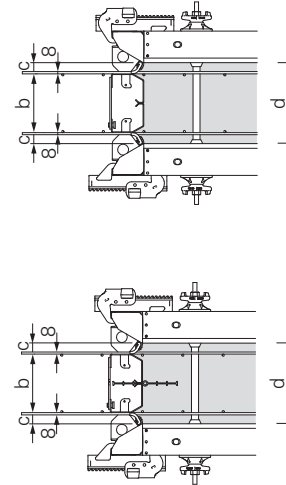

Fig. A11.02

Concrete cover c:

$$c = \frac{d - b}{2} - \varnothing \text{ Reinforcement}$$



The rubber lip (56.1) allows a continuous reinforcement thickness of 16 mm.

Assembly without water bar

1. Position primary formwork.
 2. Attach Outside Piece AT (56) by means of Alignment Coupler DRS (20).
 3. Install first row of reinforcement.
 4. Place Centre Piece MT (57) in position.
 5. Install second row of reinforcement.
 6. Position closing formwork.
 7. Install Outside Piece AT (56) in Centre Piece MT.
 8. Fix with Alignment Coupler DRS (20).
- (Fig. A11.03)

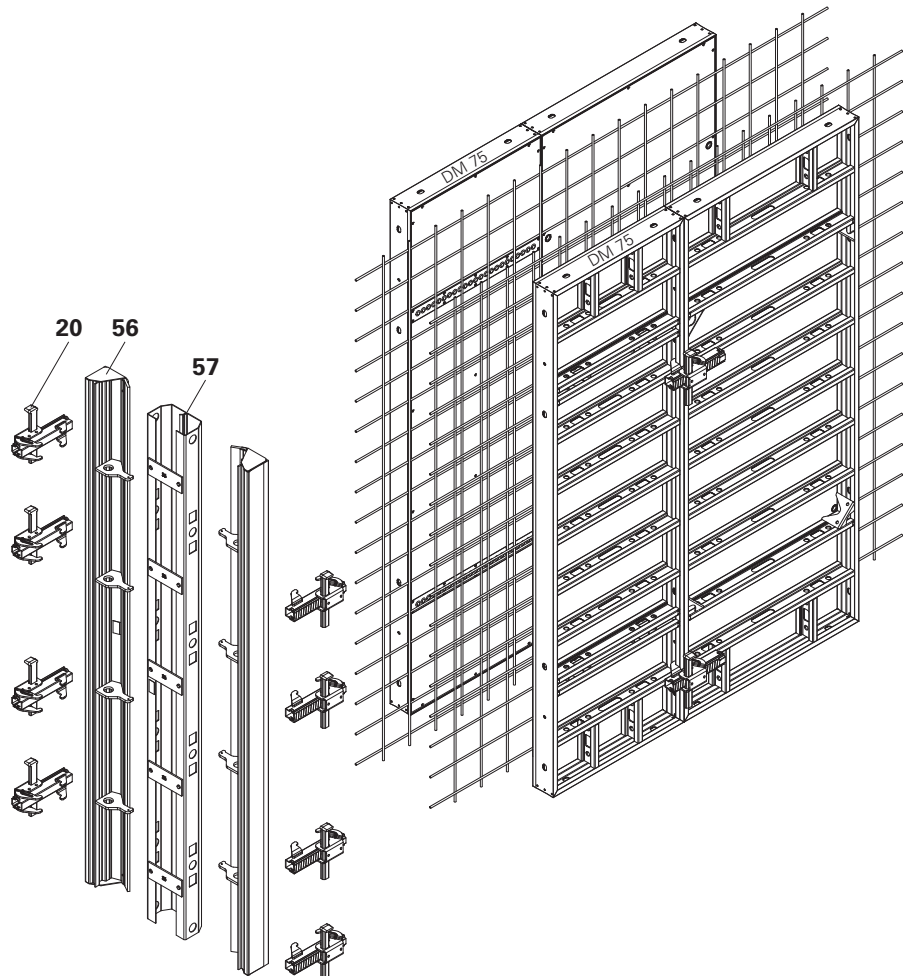

Fig. A11.03

Assembly with water bar

1. Position primary formwork.
2. Attach Outside Piece AT (56) by means of Alignment Coupler DRS (20).
3. Install first row of reinforcement.
- 4. Place Centre Piece MTF (58) in position and install water bar.**
5. Install second row of reinforcement.
6. Position closing formwork.
7. Install Outside Piece AT (56) in Centre Piece MTF.
8. Fix with Alignment Coupler DRS (20). (Fig. A11.04)

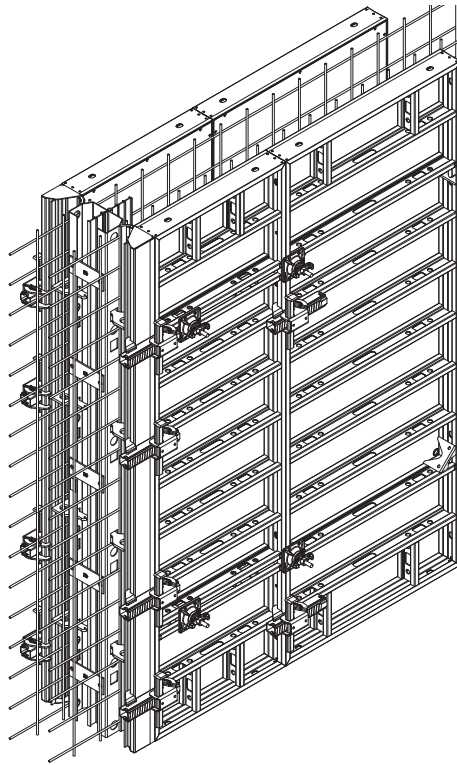
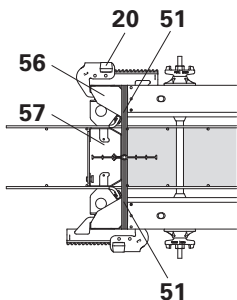

Fig. A11.04

Stopend panel with expandable water bar

Required components

56	Outside Piece AT	2x
57	Centre Part MTF	1x
51	Filler plates supplied by the contractor	2x



H = 2.50 m
AT 250x3
AT 250x5

MT 250x20
MT 250x24/25
MT 250x30
MT 250x35/36

MTF 250x20
MTF 250x24/25
MTF 250x30
MTF 250x35/36

H = 1.25 m
AT 125x3
AT 125x5

MT 125x20
MT 125x24/25
MT 125x30
MT 125x35/36

MTF 125x20
MTF 125x24/25
MTF 125x30
MTF 125x35/36

b [mm]	Wall thickness d [cm]							
	Concrete cover approx. 25 mm				Concrete cover approx. 50 mm			
	20	24/25	30	35/36	24/25	30	35/36	40
-	2	2	2	2				
-					2	2	2	2
	without water bar				without water bar			
118	1				1			
158		1				1		
218			1				1	
268				1				1
	with water bar				with water bar			
118	1				1			
158		1				1		
218			1				1	
268				1				1
-	2	2	2	2				
-					2	2	2	2
	without water bar				without water bar			
118	1				1			
158		1				1		
218			1				1	
268				1				1
	with water bar				with water bar			
118	1				1			
158		1				1		
218			1				1	
268				1				1

Scaffold Bracket DG 85

Together with the Scaffold Bracket DG 85, a concreting scaffold is mounted to the DOMINO formwork. (Fig. A12.01)

Required components

63	Scaffold Bracket DG 85	1x
66	Guardrail Post HSGP-2	1x
67	Side Mesh Barrier PMB or Guardrail Boards	1x

Technical data

Permissible load: 150 kg/m²
(Load Class 2).

Max. width of influence: 2.00 m.



Secure planking.

Decking components and guardrails must be mounted securely in position at all times.



With extended formwork units, the working scaffold is mounted as part of the pre-assembly process.

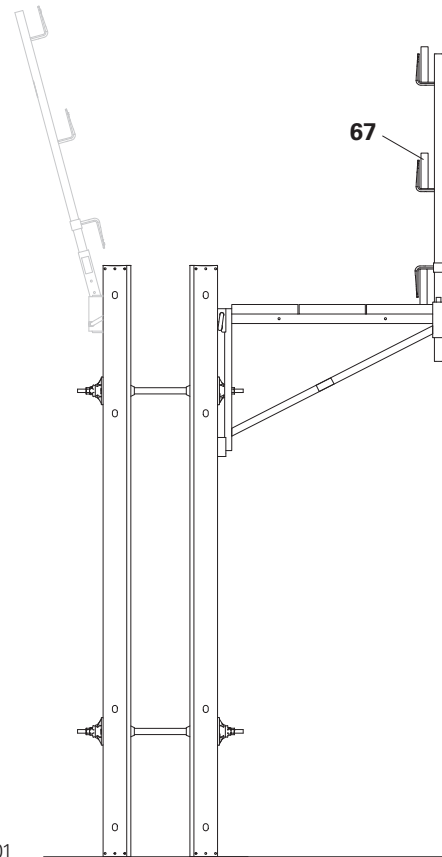
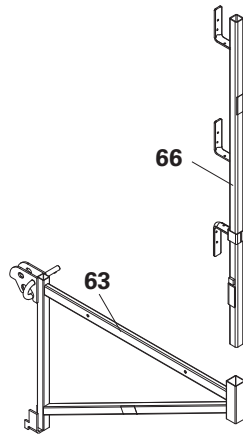

Fig. A12.01

Scaffold Bracket DG 85

Assembly

1. Insert Guardrail Post HSGP-2.
2. Slide back fastening bolts (63.1).
3. Hook in Scaffold Brackets (63) into the connecting holes of the panel and secure with the securing bolts.
(Fig. A12.02)



Visual check of the suspension equipment!

4. Install planking from below over the complete width of the brackets and secure in position.
5. Mount Side Mesh Barrier PMB or install guardrail boards, and then secure.
6. Mount side protection, e.g. End Hand-rail Frame 55 (64).
(Fig. A12.03)

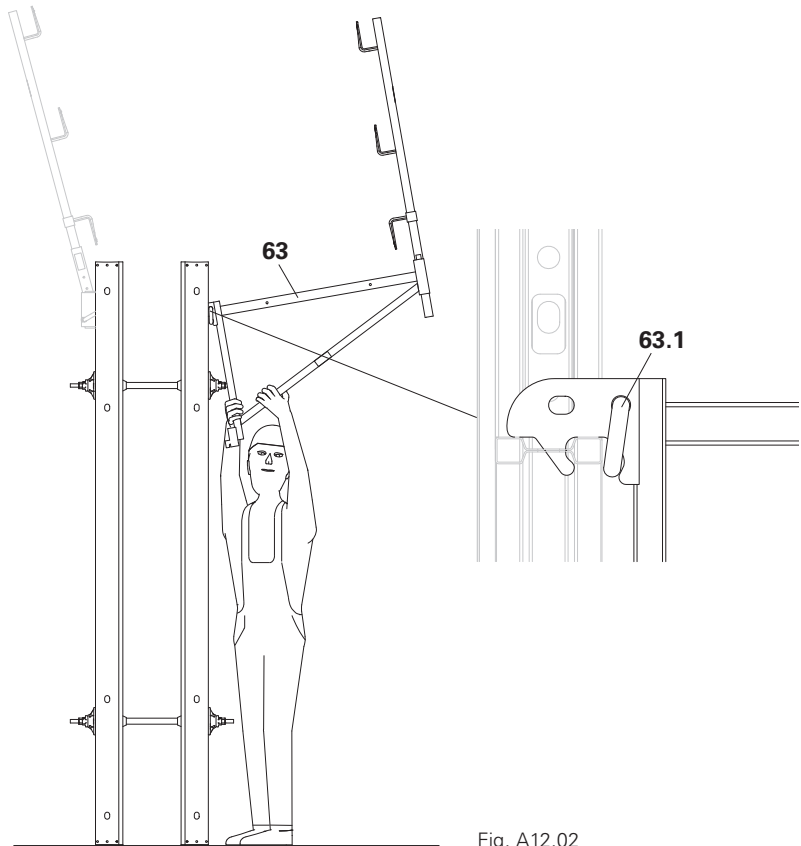

Fig. A12.02

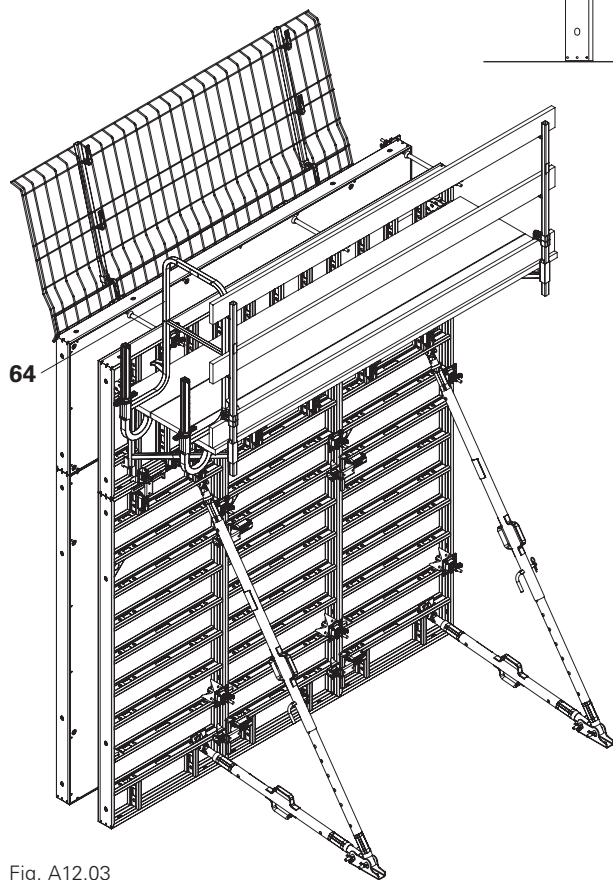

Fig. A12.03

Guardrails

Assembly is carried out horizontally. In case of vertical assembly use e.g. a mobile scaffold.

Required components

65	Guardrail Post Holder	1x
66	Guardrail Post HSGP-2	1x
67	Side Mesh Barrier PMB or Guardrail Boards	1x

(Fig. A12.04)

Technical data

Max. width of influence: 2.00 m.

Assembly

1. Slide back fastening bolts (63.1) and hook in Handrail Post Holder DOMINO (65) in the connecting holes of the panel.
2. Secure with cotter pins.
3. Insert Guardrail Post HSGP-2 (66).
4. Mount Side Mesh Barrier PMB (67) or install guardrail boards, and then secure.

(Fig. A12.05)

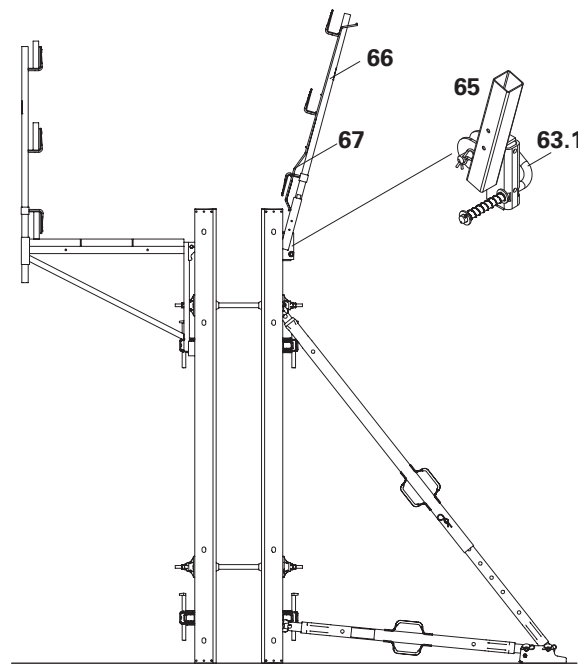

Fig. A12.04



When erecting, make sure that the guardrails are not damaged by the lifting gear.

Assembly is only possible on vertical struts.

With extended formwork units, the guardrails are mounted as part of the pre-assembly process.

Dismantling

Do not lay the formwork panel on the Handrail Post Holder DOMINO (65).

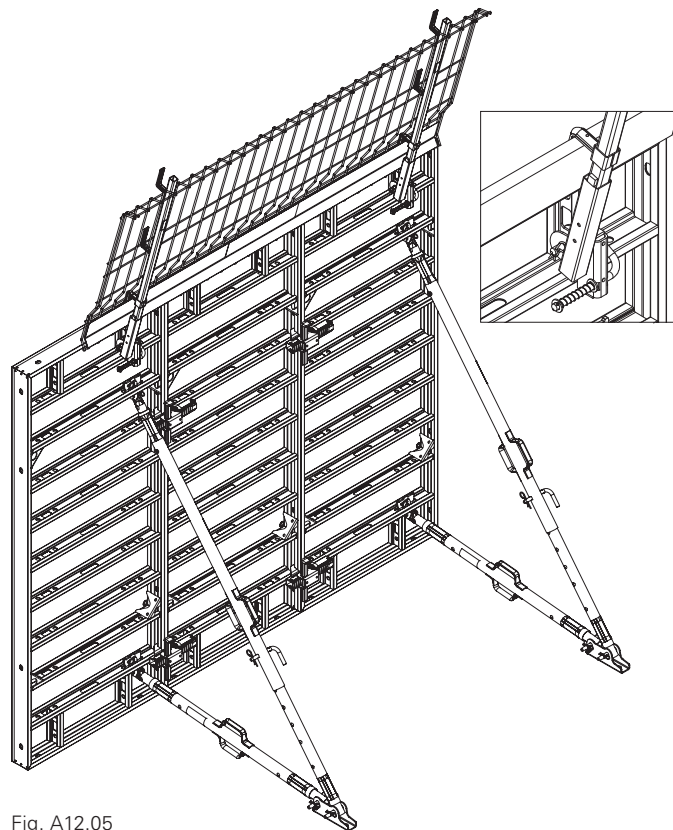

Fig. A12.05

Extension guidelines for horizontal pre-assembly up to $h = 5.00\text{ m}$



Do not exceed permissible load-bearing capacity of the DOMINO Lifting Hook (500 kg) and the crane capacity!



Extension possibilities, number and arrangement of DRS Alignment Couplers, DAR 80 Compensation Walers and formwork anchors are featured on the DOMINO poster.

Panel connections

With one or more horizontal and vertical panel joints, always use the DRS Alignment Coupler (20). (Fig. A13.01 – A13.05)

Pre-assemble the extension unit in a horizontal position with the formlining facing downwards. Place timbers or planks in position as support. The assembly surface must be level.

Erection by crane.
(Fig. A13.06)

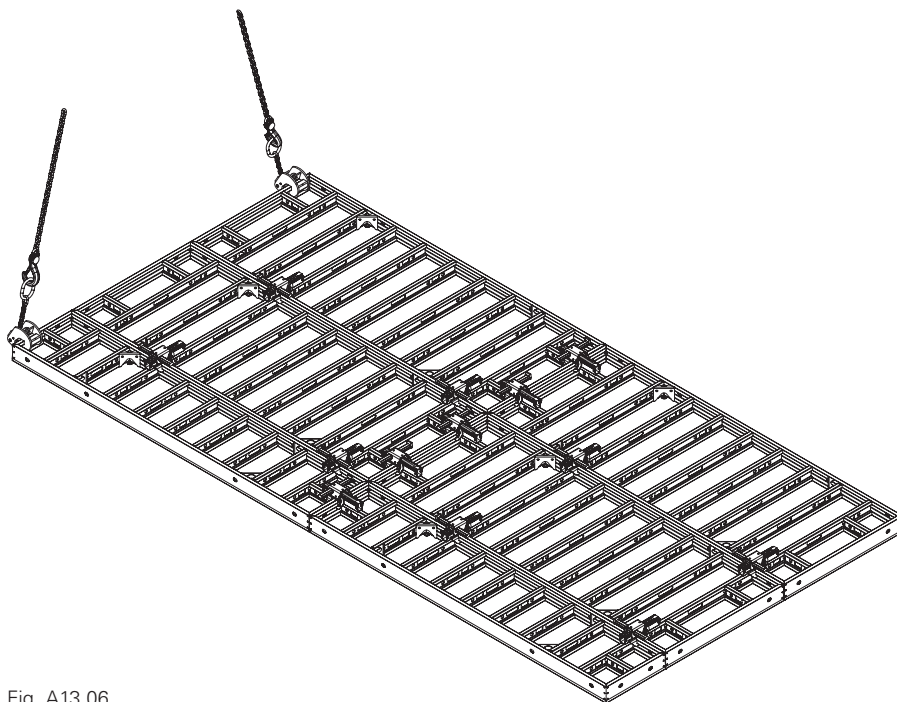

Fig. A13.06

25/35 cm

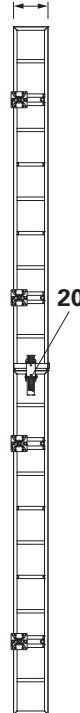

Fig. A13.01

50 cm

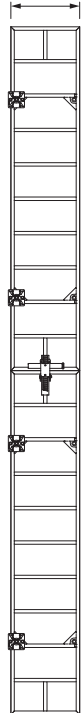

Fig. A13.02

75 cm

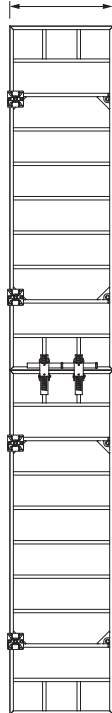

Fig. A13.03

50 cm

100 cm

100 cm

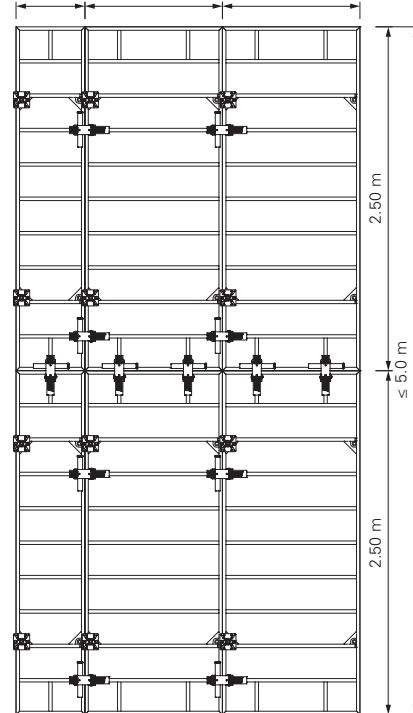

Fig. A13.04

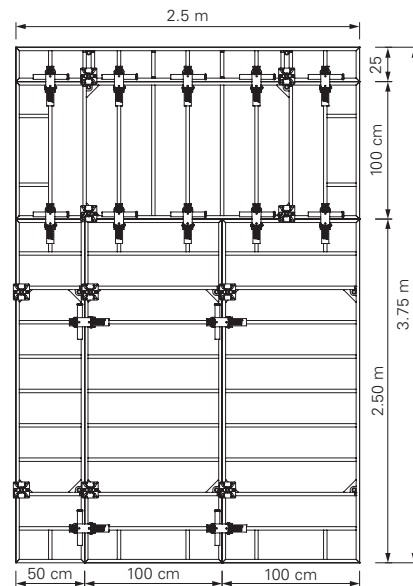

Fig. A13.05

Foundation formwork

All DOMINO panels are suitable for shuttering foundations.
In addition, DOMINO panels with $h = 125$ and $h = 150$ have inset tie points and can be used horizontally without any problems.
(Fig. A14.01 + A14.01b)

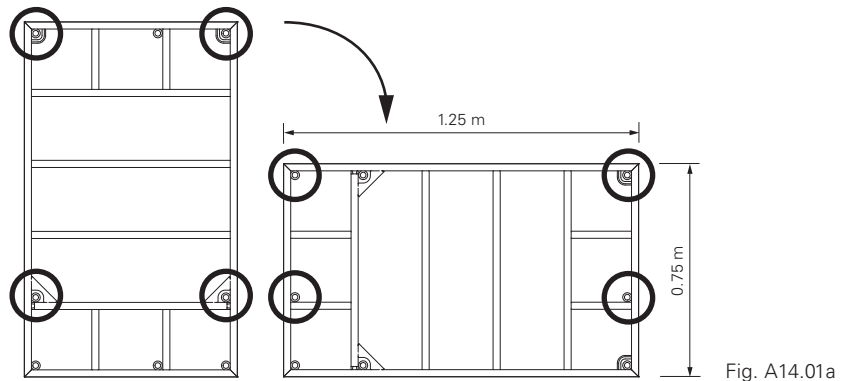

Fig. A14.01a

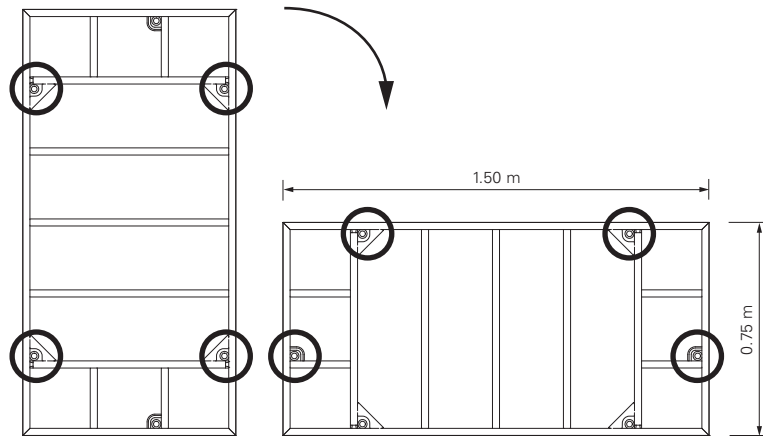
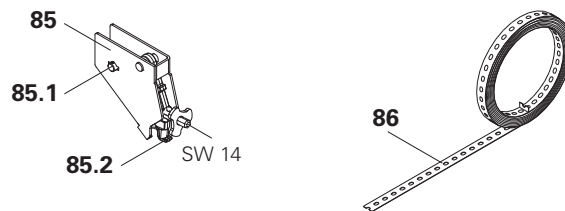

Fig. A14.01b

Foundation Tie Clamp

If the bottom tie positions are missing in the strip and individual foundations, the Foundation Tie Spanner DLS together with the Perforated Foundation Tie is used.



Required length of Perforated Foundation Tie:

Foundation width + 50 cm.

Assembly

1. Position the panel on the Perforated Foundation Tie (86).
2. Fix the Foundation Tie Spanner (85) in the lowest connecting hole by means of bolts (85.1).
3. Attach Perforated Foundation Tie to the Tensioning Lever (85.2).
4. Tension using Ratchet, SW 14. (Fig. A14.02)

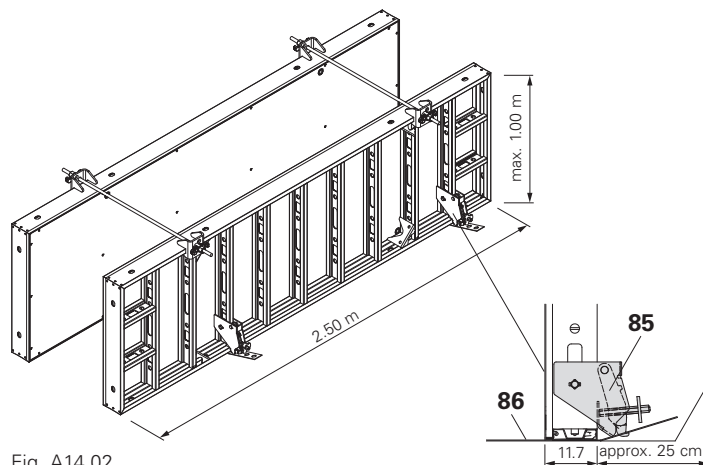

Fig. A14.02

Technical data Permissible tension force: 12.9 kN (for foundation formwork).

Panels

When using DOMINO Alu panels, the same formwork guidelines apply as for the DOMINO 250 Steel.

Available panel widths for h = 2.5 m and 1.25 m:
100 / 75 / DMA 75 cm.
(Fig. A15.01 + A15.06)



- It can be combined with DOMINO Steel.
- For extensions in combination with steel panels, the aluminium panels are always to be installed at the top.

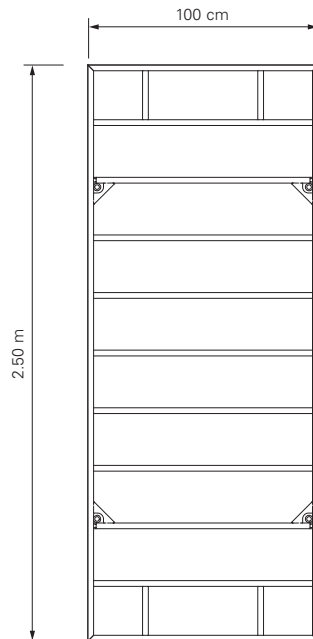

Fig. A15.01



Fig. A15.02

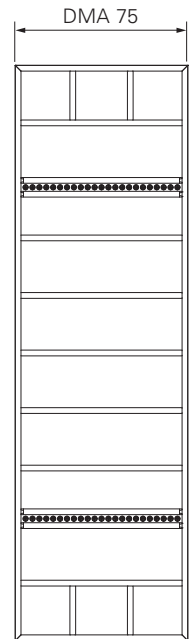

Fig. A15.03

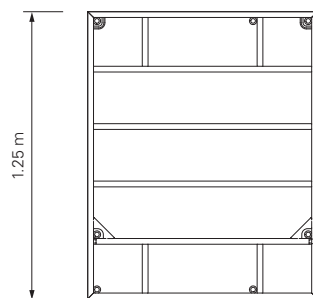

Fig. A15.04

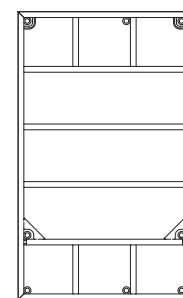

Fig. A15.05

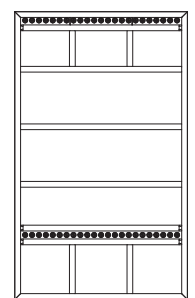
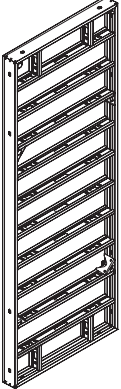
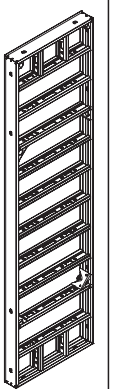
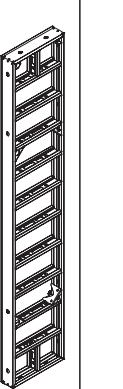
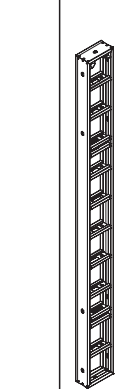
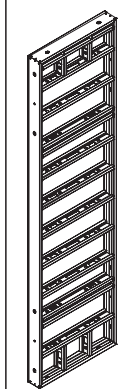
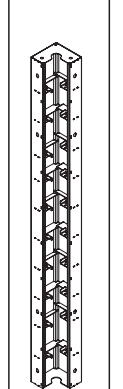
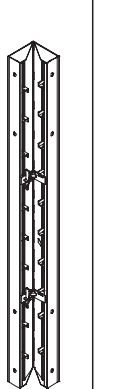
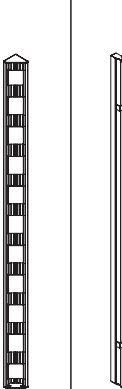
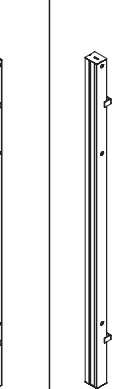
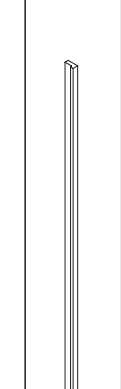

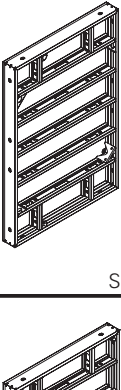
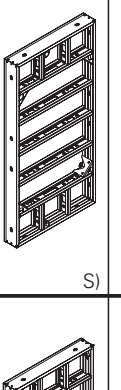
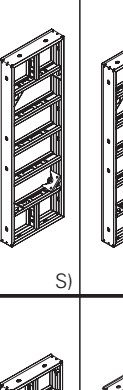
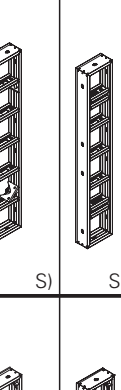
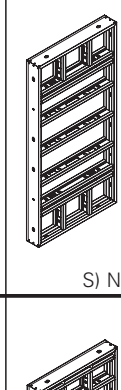
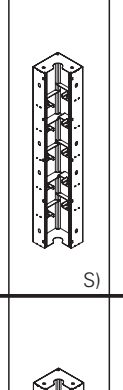
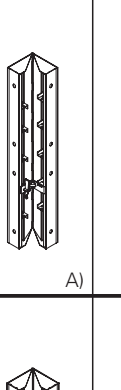
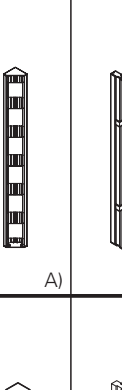
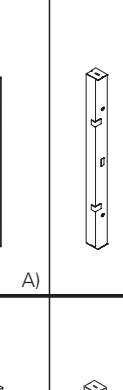
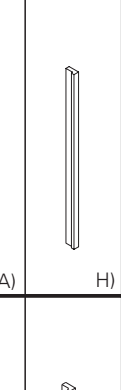

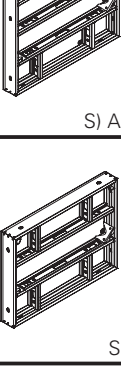
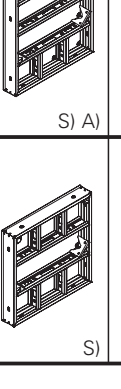
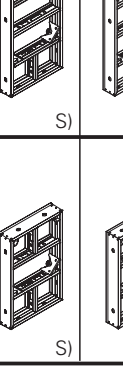
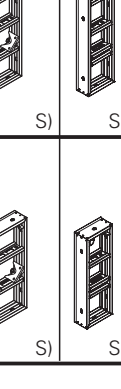
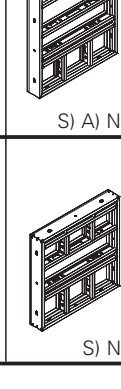
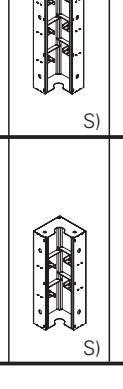
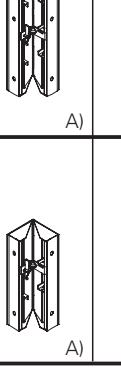
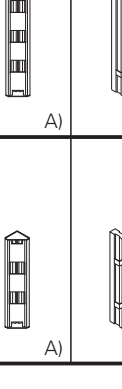















Fig. A15.06

Width Height	100	75	50	35	25	DM 75 Multi-Purpose Panel	DISE Internal Steel Corner	DGE Articulated Corner	DAW Outside Corner Angle	DWD 5 Wall Thickness Compensation	DWD 10 Wall Thickness Compensation	DPA Filler Support
275	 S)	 S) A)	 S)	 S)	 S)	 S) A) N)	 S)	 A)	 A)	 A)	 A)	 H)
150	 S)	 S)	 S)	 S)	 S)	 S) N)	 S)	 A)	 A)	 A)	 A)	 H)
125	 S) A)	 S) A)	 S)	 S)	 S)	 S) A) N)	 S)	 A)	 A)	 A)	 A)	 H)
75	 S)	 S)	 S)	 S)	 S)	 S) N)	 S)	 A)	 A)	 A)		

Key

- S) Panels with steel frames (red powder-coated)
- A) Panels with aluminium frames (yellow powder-coated)
- N) Standard panels or multi-purpose panels
- H) Timber panels

Alu panels

When using the aluminium panels, the same formwork guidelines apply as for the h = 250 connections and extensions.

Standard joint

2 x Alignment Coupler DRS (20).
(Fig. B2.01)

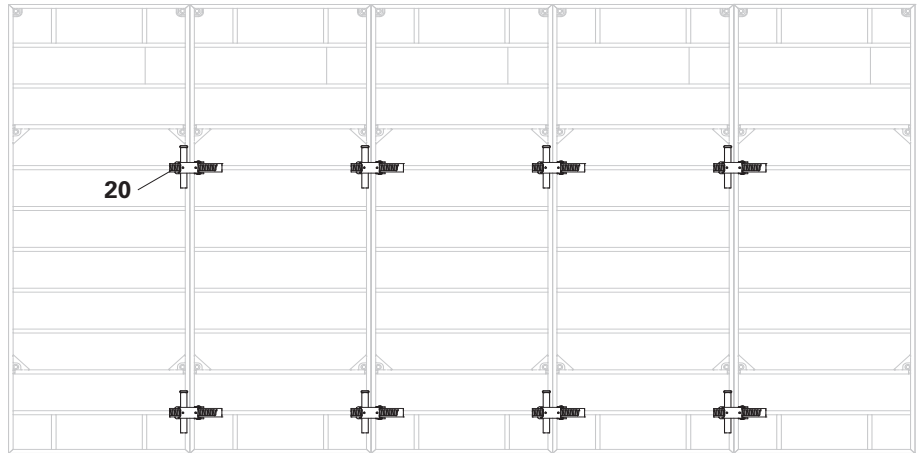

Fig. B2.01

90° corners

External corner

Required components

11	Panel ... x 50	2x
12	External Corner Angle DAW	1x
20	Alignment Coupler DRS per side	3x

(Fig. B2.02)



First install the right Alignment Coupler DRS and then the left one. Mounting the other way round is not possible.

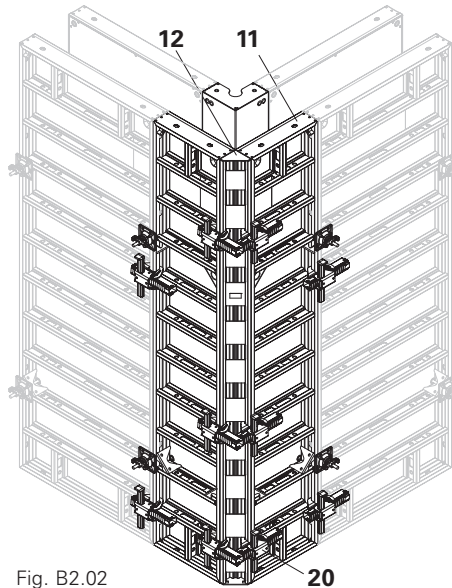

Fig. B2.02

Internal corner

Required components

13a	Inside Steel Corner DISE	1x
20	Alignment Coupler DRS	2x

(Fig. B2.03a)

Alternatively:
Articulated Corner DGE (13b) with
2 x Corner Locking 90° (13.1).
(Fig. B2.03b)

For the number of Alignment Couplers required for other panel heights: see DOMINO poster.

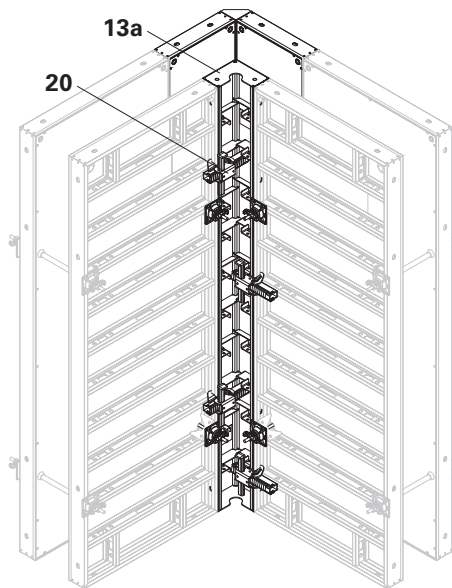

Fig. B2.03a

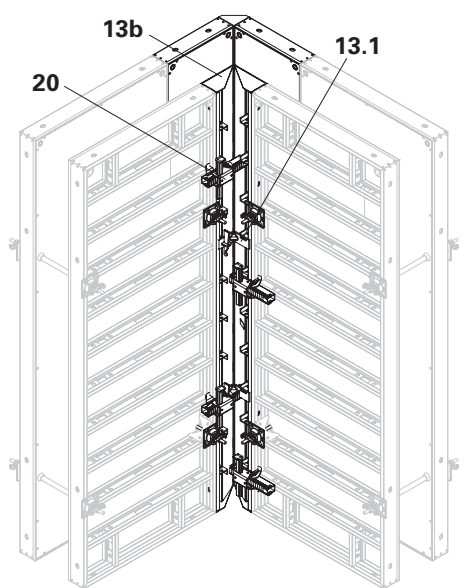

Fig. B2.03b

Internal corner

Required components

20 Alignment Coupler DRS	4x
---------------------------------	----

For 135° corners use additional
2 Positioning Pins 135° inside (13.1).
(Fig. B3.01)

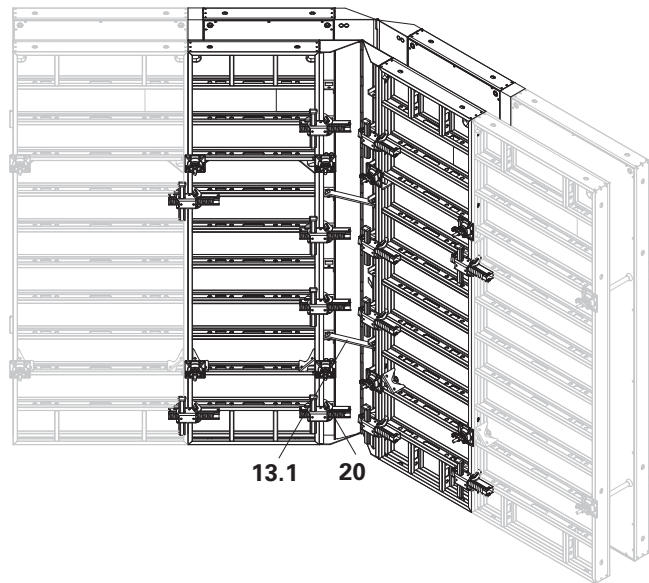

Fig. B3.01

External corner

Required components

20 Alignment Coupler DRS	5x
21 Compensation Waler DAR 80	2x

For 135° corners use additional
2 Positioning Pins 135° outside (13.1).
(Fig. B3.02)

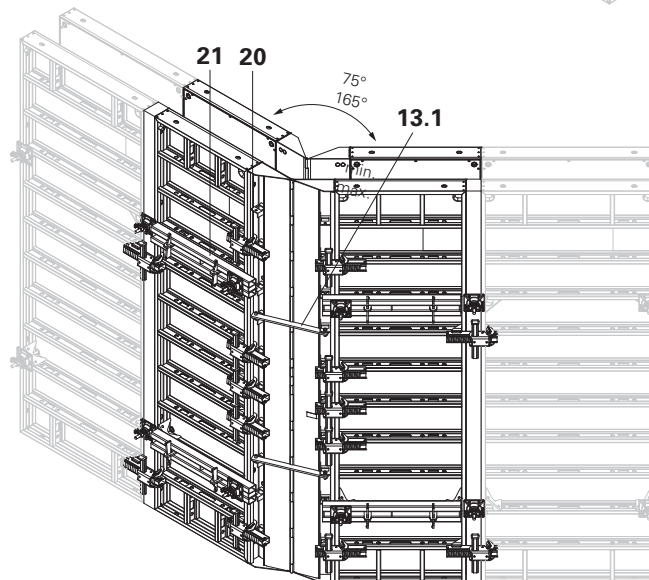

Fig. B3.02

B4 Stopend Formwork

Stopend formwork with timber and plywood fillers

For wall thicknesses up to 36.5 cm.

Required components

21 Compensation Waler DAR 80	3x
25 Stopend Tie DSA	6x
33 Wingnut Pivot Plate	6x
55 Top Tie Bracket DAH with tie set	6x

(Fig. B4.03)

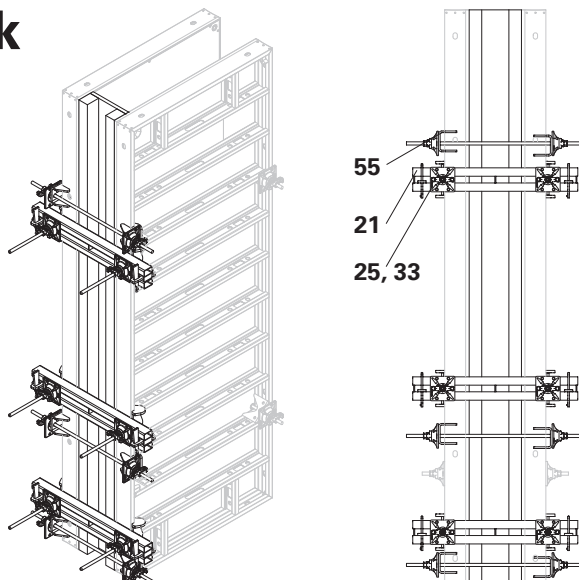

Fig. B4.01

Stopend panel reinforcement with water bar

Required components

56	Outside Piece AT 3	2x
	Concrete cover approx. 2.5 cm	
56	Outside Piece AT 5	2x
	Concrete cover approx. 5 cm	
57	Centre Part MTF	1x

(Fig. B4.02)



The rubber lip (56.1) allows a continuous reinforcement thickness of 16 mm.

Assembly without and with water bar or expandable water bar: see A12.

Installation (Fig. B4.03)

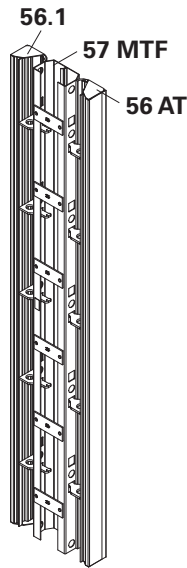

Fig. B4.02

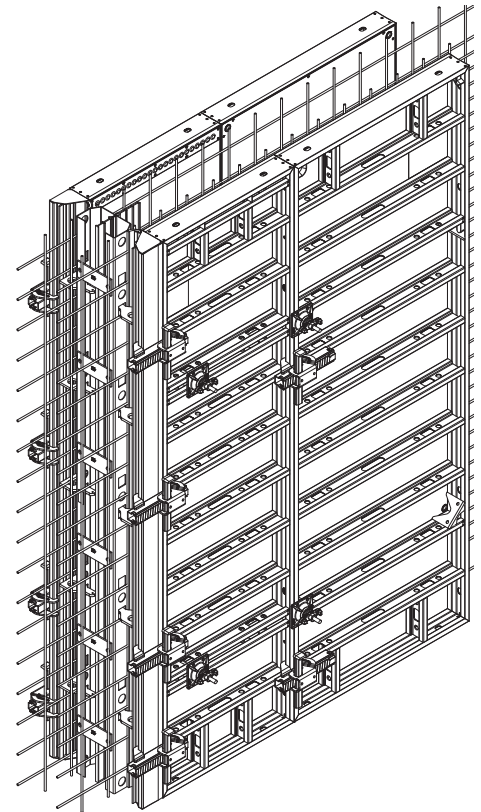
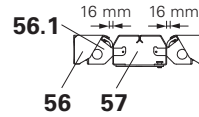
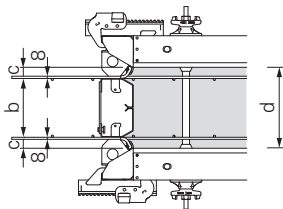

Fig. B4.02

Concrete cover c:

$$c = \frac{d - b}{2} - \varnothing \text{ Reinforcement}$$



H = 2.75 m
AT 275x3
AT 275x5

MT 275x20
MT 275x24/25
MT 275x30
MT 275x35/36

MTF 275x20
MTF 275x24/25
MTF 275x30
MTF 275x35/36

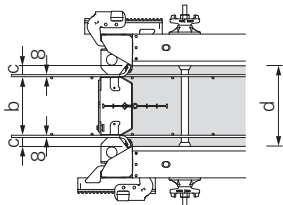

b [mm]	Wall thickness d [cm]							
	Concrete cover approx. 25 mm				Concrete cover approx. 50 mm			
	20	24/25	30	35/36	24/25	30	35/36	40
-	2	2	2	2				
-					2	2	2	2
	without water bar				without water bar			
118	1				1			
158		1				1		
218			1				1	
268				1				1
	with water bar				with water bar			
118	1				1			
158		1				1		
218			1				1	
268				1				1

Extension guidelines for horizontal pre-assembly up to $h = 5.25\text{ m}$

See also A13 Height Extensions.

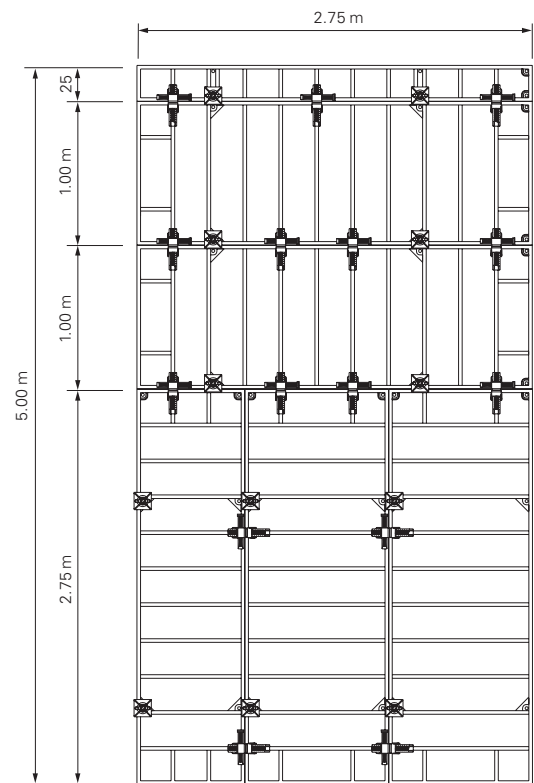
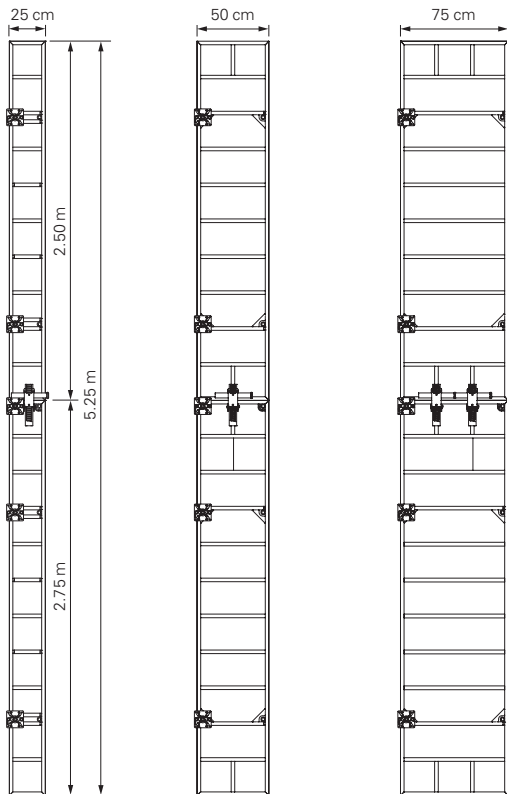

Width Height	100	75	50	35	25	DM 75 Multi-Purpose Panel	DISE Internal Corner	DGE Articulated Corner	DAW Outside Corner Angle	DWD 5 Wall Thickness Compensation	DWD 10 Wall Thickness Compensation	DPA Filler Support
300												
150												
125												
75												

Key

- S) Panels with steel frames (red powder-coated)
- A) Panels with aluminium frames (yellow powder-coated)
- N) Standard panels or multi-purpose panels
- H) Timber panels

Alu panels

When using the aluminium panels, the same formwork guidelines apply as for the h = 250 connections and extensions.

Standard panel joint

3 x Alignment Coupler DRS (20).
(Fig. C2.01)

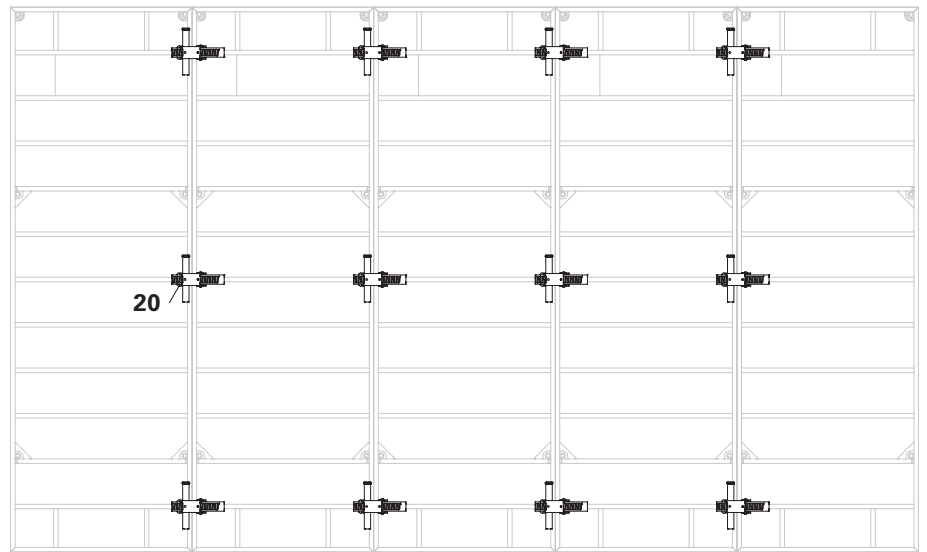

Fig. C2.01

90° corners

External corner

Required components

11	Panel ... x 50	2x
12	External Corner Angle DAW	1x
20	Alignment Coupler DRS per side	3x

(Fig. C2.02)



First install the right Alignment Coupler DRS and then the left one. Mounting the other way round is not possible.

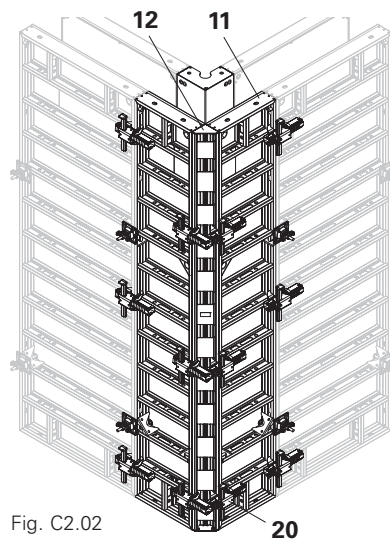

Fig. C2.02

Internal corner

Required components

13a	Inside Steel Corner DISE	1x
20	Alignment Coupler DRS	3x

(Fig. C2.03a)

Alternatively:
Articulated Corner DGE (13b) with
2 x Corner Locking 90° (13.1).
(Fig. C2.03b)

For the number of Alignment Couplers required for other panel heights: see DOMINO poster.

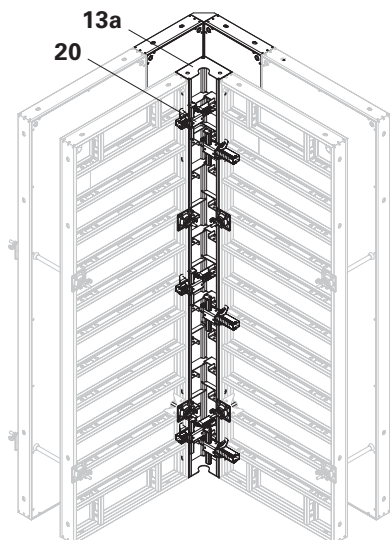

Fig. C2.03a

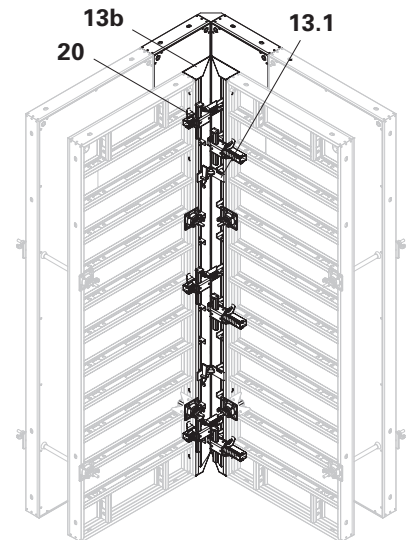

Fig. C2.03b

Internal corner

Required components

20 Alignment Coupler DRS	4x
---------------------------------	----

For 135° corners use additional 2 Positioning Pins 135° inside (13.1).
(Fig. C3.01)

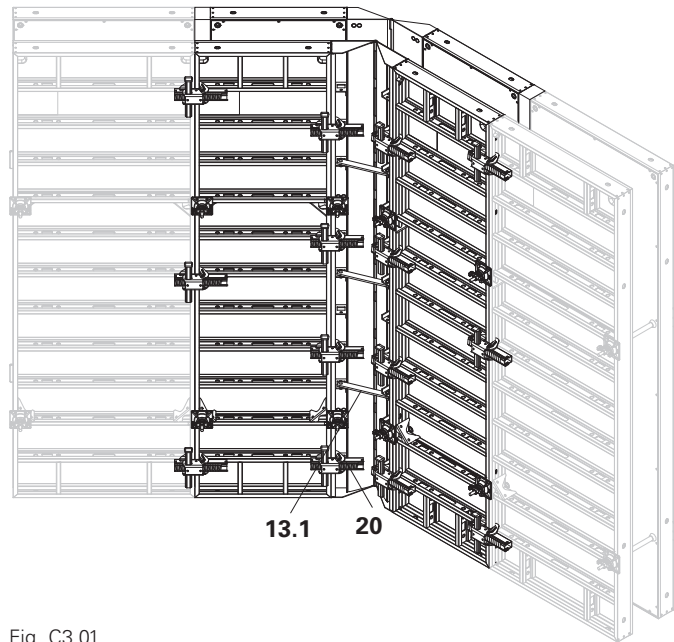

Fig. C3.01

External corner

Required components

20 Alignment Coupler DRS	5x
21 Compensation Waler DAR 80	2x

For 135° corners use additional 2 Positioning Pins 135° outside (13.1).
(Fig. C3.02)

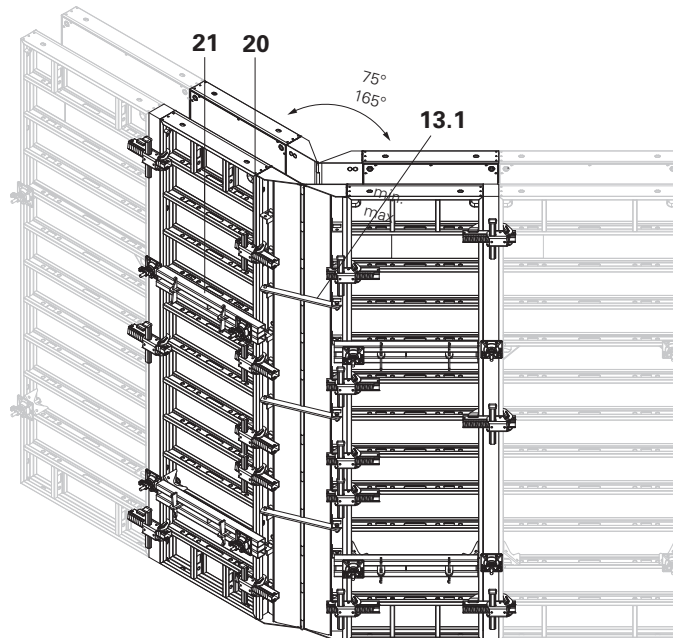

Fig. C3.02

Stopend formwork with timber and plywood fillers

For wall thicknesses up to 36.5 cm.

Required components

21	Compensation Waler DAR 80	3x
25	Stopend Tie DSA	6x
33	Wingnut Pivot Plate	6x
55	Top Tie Bracket DAH with tie set	6x

(Fig. C4.01)

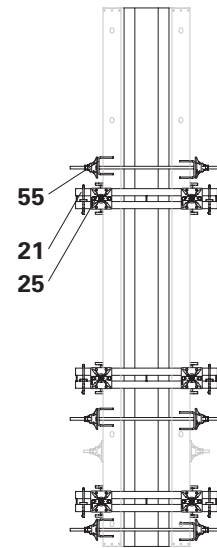
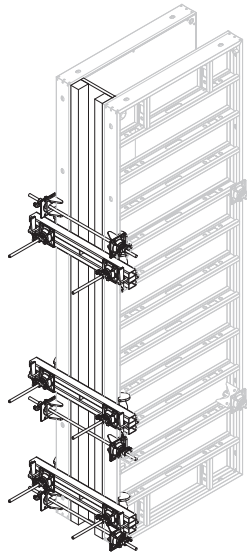
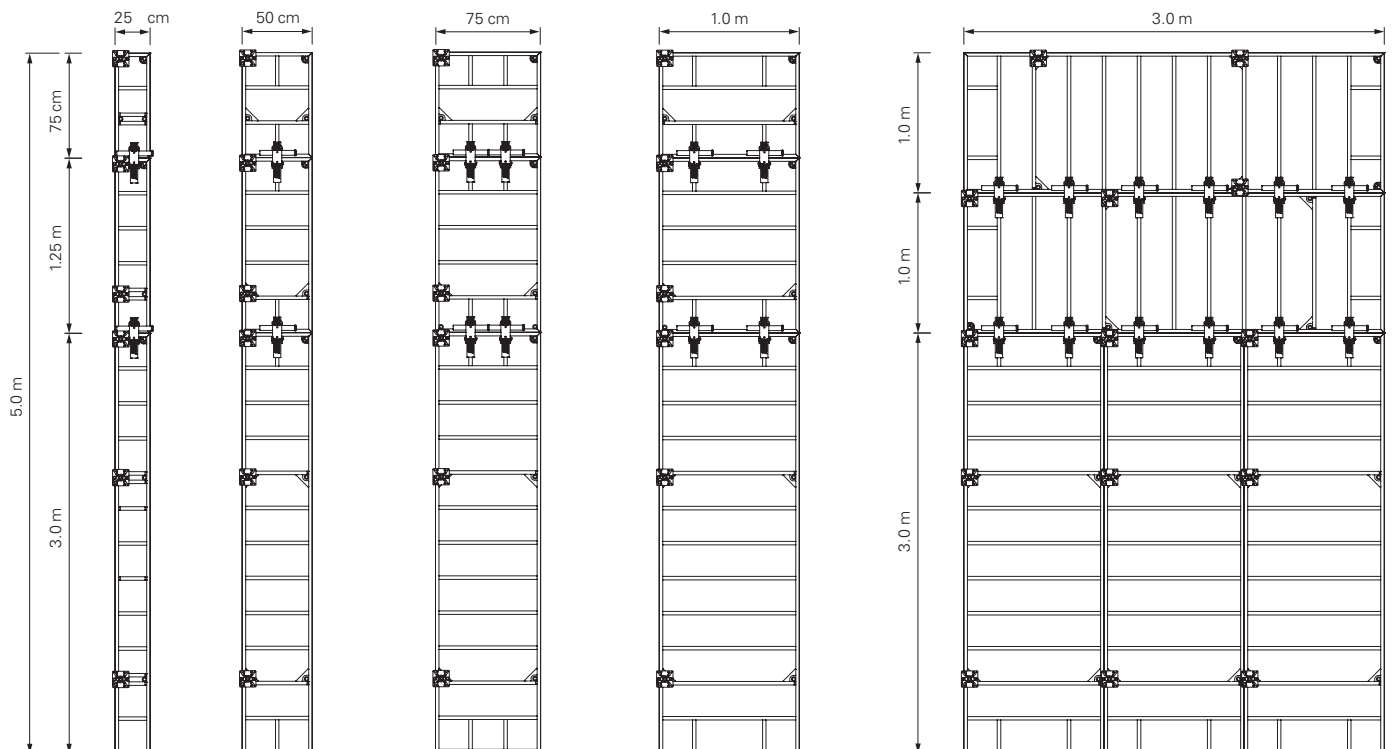

Fig. C4.01

Extension guidelines for horizontal pre-assembly up to h = 5.0 m

See also A13 Height Extensions.



DOMINO Panel Formwork



Item no.	Weight kg
066000	102,000

Panel D 300 x 100
Steel panel with 15 mm plywood.

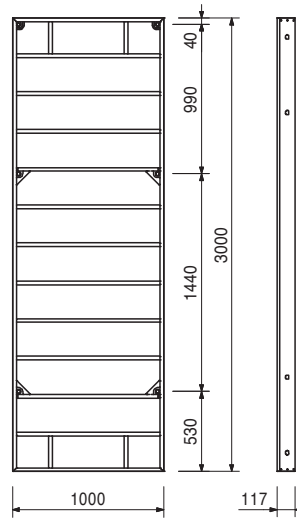
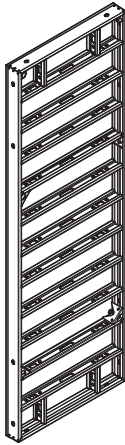

066002	83,100
--------	--------

Panel D 300 x 75
Steel panel with 15 mm plywood.

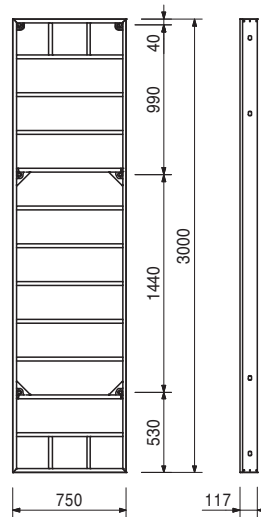
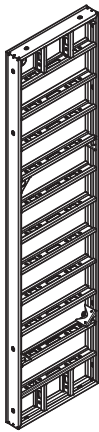

066005	63,300
--------	--------

Panel D 300 x 50
Steel panel with 15 mm plywood.

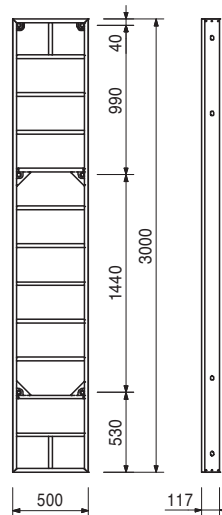

DOMINO Panel Formwork



Item no.	Weight kg
066006	43,700

Panel D 300 x 25
Steel panel with 15 mm plywood.

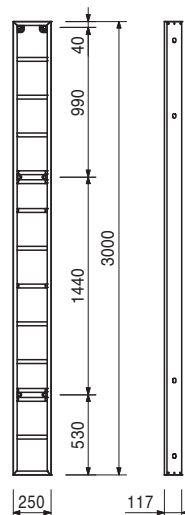

066004	90,600
--------	--------

Multi Panel DM 300 x 75
Steel panel with 15 mm plywood. For oblique angles, wall connections etc.

Complete with
69 pc. 030290 Plug Ø 20 mm.

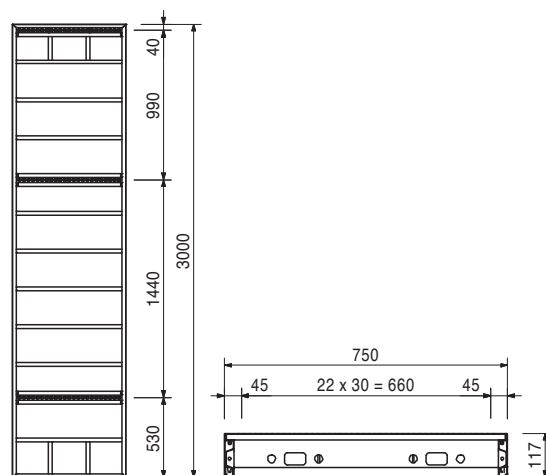
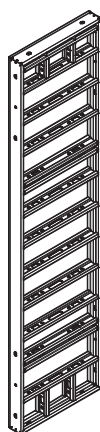

126298	80,400
--------	--------

Inside Steel Corner DISE 300
For 90° internal corners.

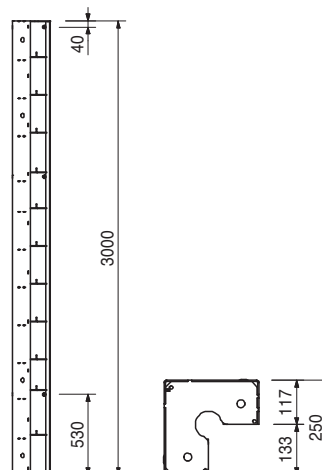

Item no.	Weight kg
066009	47,800

Articulated Corner DGE 300

Alu panel with aluminium formlining. For oblique angles from 75°, can be used internally and externally.

Complete with

2 pc. 066100 Positioning DEA 90°.

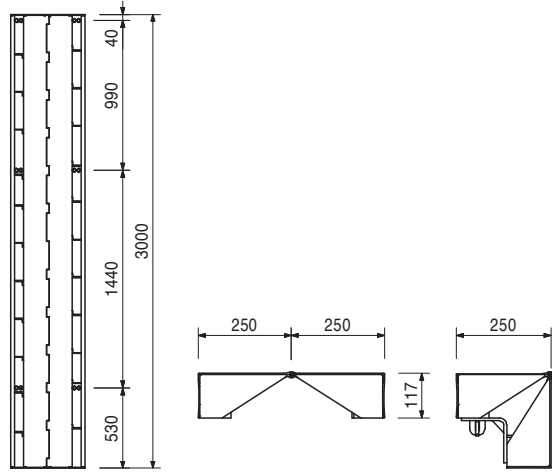

066010	9,360
--------	-------

Wall Thickness Compensation DWD 300 x 5

For adjusting to wall thicknesses in corners: with DOMINO.

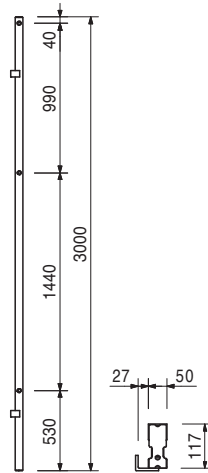

066008	12,500
--------	--------

External Corner DAW 300

For panel connections at 90° external corners.

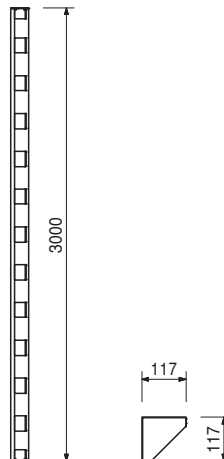

Item no. Weight kg

066011	5,000
066012	4,700

Filler Supports DPA 300
Filler Support DPA 300
Filler Support DPA 300/27

For compensation with 21 or rather 27 mm filler plates.

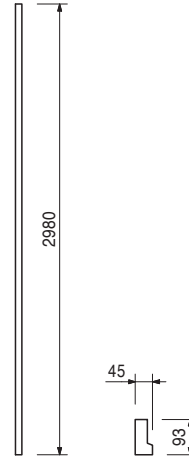

111617 167,000

Shaft Panel DSE 300

Element for moving complete internal shaft formwork.

Technical Data

Permissible load-bearing point capacity 2.0 t.

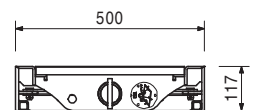
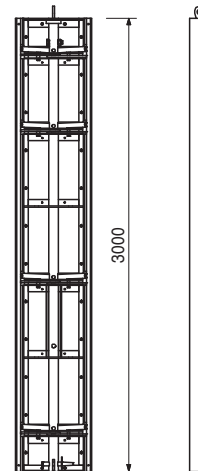

111665 4,360

Accessories

Spindle Shaft Element DSE

DOMINO Panel Formwork



Item no.	Weight kg
066087	2,550

Chamfer Strip DSD 300

For DOMINO Column Formwork and external corners.

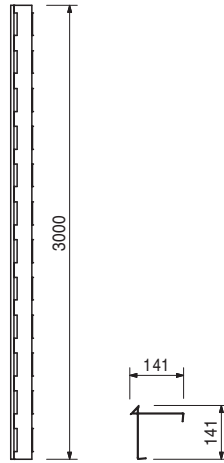

066013	55,400
066014	52,000
066015	48,300
066016	39,000

Column Panels DS 300

Column Panel DS 300 x 40
Column Panel DS 300 x 35
Column Panel DS 300 x 30
Column Panel DS 300 x 20

B

400
 350
 300
 200

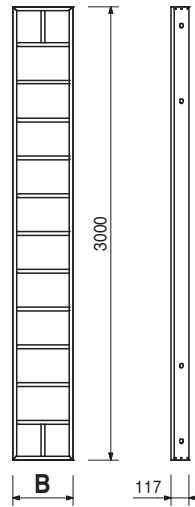

DOMINO Panel Formwork

Item no.	Weight kg
105724	95,400

Panel D 275 x 100
Steel panel with 15 mm plywood.

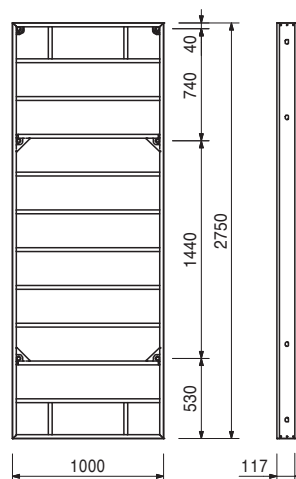
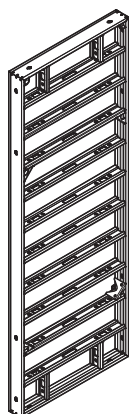

105706	87,800
--------	--------

Panel D 275 x 75
Steel panel with 15 mm plywood.

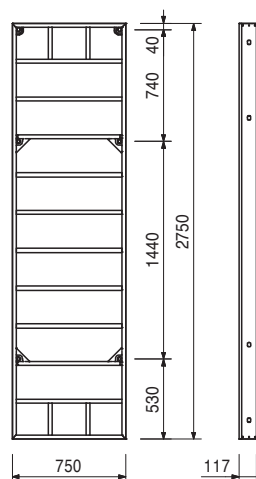
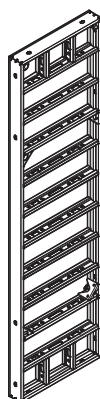

105695	59,200
--------	--------

Panel D 275 x 50
Steel panel with 15 mm plywood.

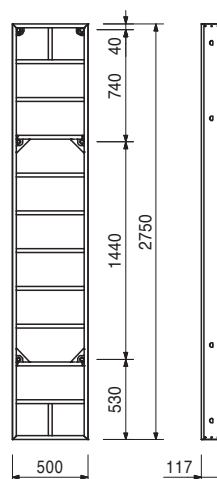

DOMINO Panel Formwork



Item no.	Weight kg
105686	41,000

Panel D 275 x 25
Steel panel with 15 mm plywood.

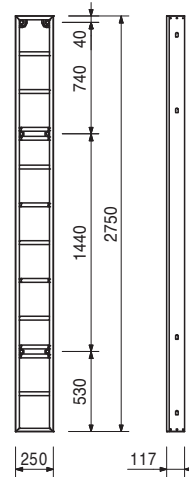
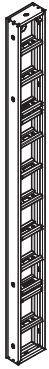

105910	53,400
--------	--------

Panel Domino DA Alu 275 x 75
Aluminum panel with 15 mm plywood.

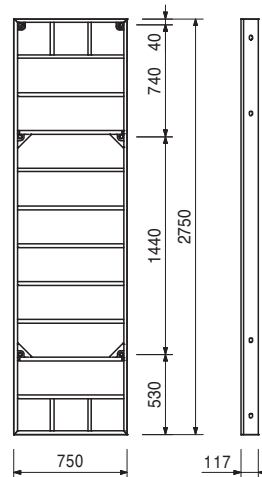
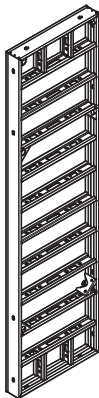

105735	84,500
105913	55,900

Multi Panels DM/DMA 275
Multi Panel DM 275 x 75
Multi Panel DMA 275 x 75
Steel panel with 15 mm plywood. For oblique angles, wall connections etc.

Complete with
69 pc. 030290 Plug Ø 20 mm.

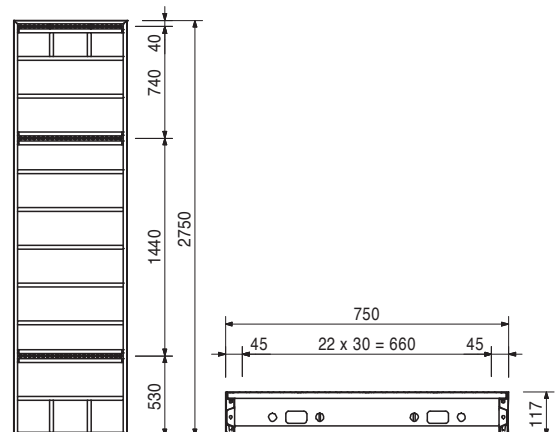
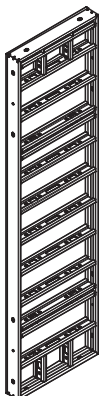

Item no.	Weight kg
126292	73,700

Inside Steel Corner DISE 275
For 90° internal corners.

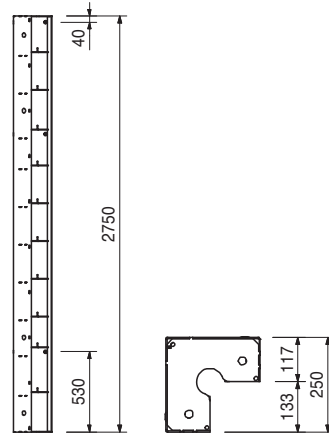

105708	44,100
--------	--------

Articulated Corner DGE 275

Alu panel with aluminium formlining. For oblique angles from 75°, can be used internally and externally.

Complete with

2 pc. 066100 Positioning DEA 90°.

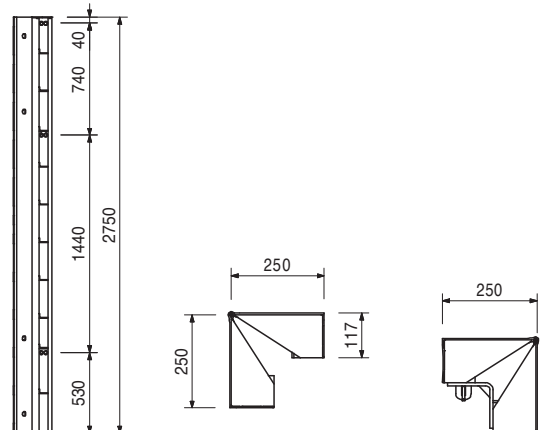

105740	8,600
105746	12,700

Wall Thickness Compensations DWD 275

Wall Thickness Compensation DWD 275 x 5

Wall Thickness Compensation DWD 275 x 10

For adjusting to wall thicknesses in corners: with DOMINO.

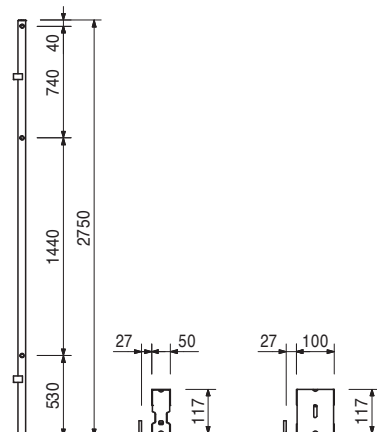

Item no.	Weight kg
105734	11,500

Outside Corner Angle DAW 275

For panel connections at 90° external corners.

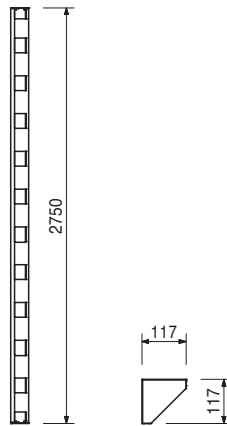

105749	4,860
105795	4,500

Filler Supports DPA 275

Filler Support DPA 275

Filler Support DPA 275/27

For compensation with 21 or rather 27mm filler plates.

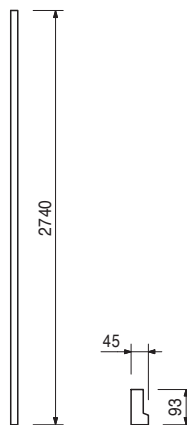

111603	148,000
--------	---------

Shaft Element DSE 275

Element for moving complete internal shaft formwork.

Technical Data

Permissible load-bearing point capacity 2.0 t.

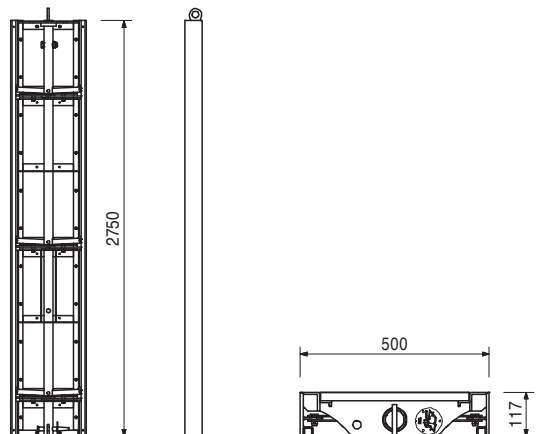

Accessories

111665	4,360
--------	-------

Spindle Shaft Element DSE

Item no.	Weight kg
111665	4,360

Spindle Shaft Element DSE

For use with internal Shaft Panel DSE. For spindling back to the starting position. 1 piece per Shaft Panel DSE.

Complete with

2 pc. 105822 Bolt \varnothing 20 x 102, galv.
2 pc. 022230 Cotter Pin 5/1, galv.

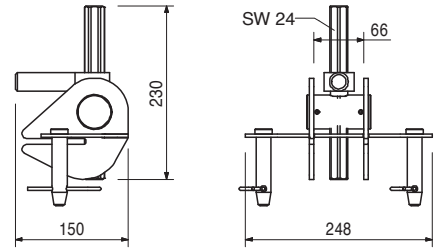
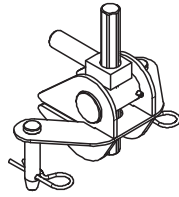

106203	17,900
108857	19,800

Stopend Panels DOMINO AT

Stopend Panel DOMINO AT 275 x 3

Stopend Panel DOMINO AT 275 x 5

External unit for stopend formwork.

Note

Concrete cover approx. 30 or 50 mm.

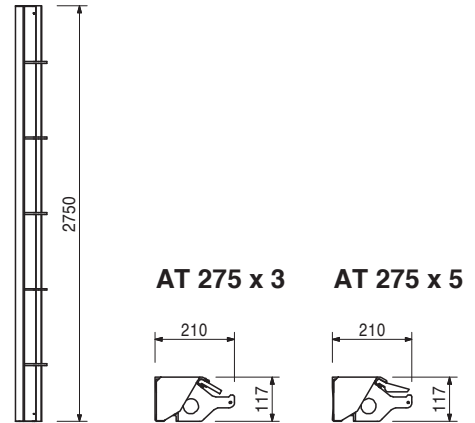

106207	30,000
106211	34,300
106215	39,700
106221	44,000

Stopend Panels DOMINO MTF 275

Stopend Panel DOMINO MTF 275 x 20

Stopend Panel DOMINO MTF 275 x 24/25

Stopend Panel DOMINO MTF 275 x 30

Stopend Panel DOMINO MTF 275 x 35/36

External unit for stopend formwork.

B

118

158

218

268

Note

Concrete cover approx. 30 or 50 mm.

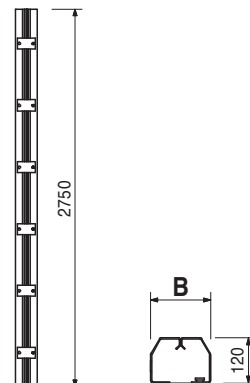

DOMINO Panel Formwork

Item no. Weight kg

066020 87,600

Panel D 250 x 100

Steel panel with 15 mm plywood.

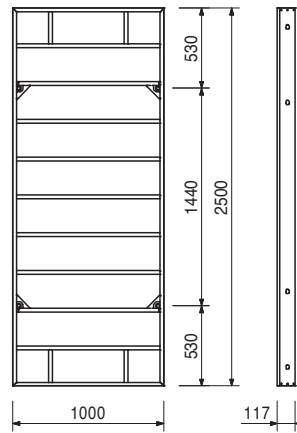
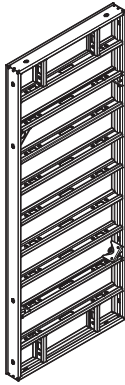

066022 71,500

Panel D 250 x 75

Steel panel with 15 mm plywood.

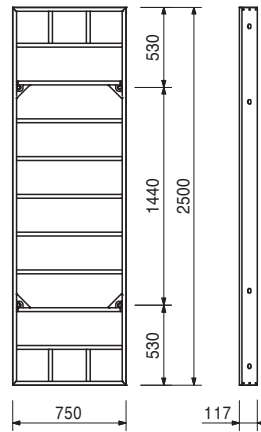
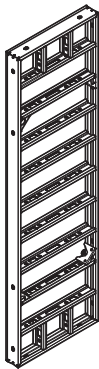

066025 54,400

Panel D 250 x 50

Steel panel with 15 mm plywood.

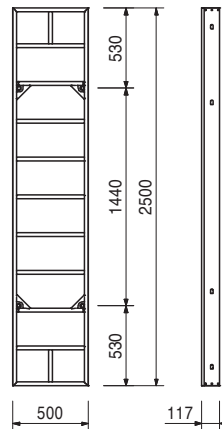

DOMINO Panel Formwork

Item no.	Weight kg
125501	44,100

Panel D 250 x 35
Steel panel with 15 mm plywood.

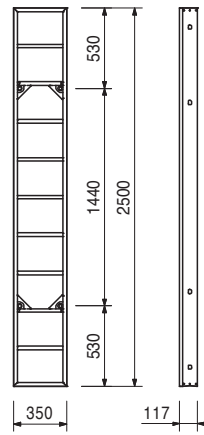

066026	37,700
--------	--------

Panel D 250 x 25
Steel panel with 15 mm plywood.

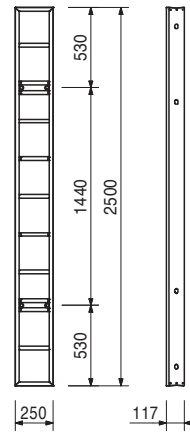

066021	59,400
--------	--------

Panel DA 250 x 100
Alu panel with 15 mm plywood.

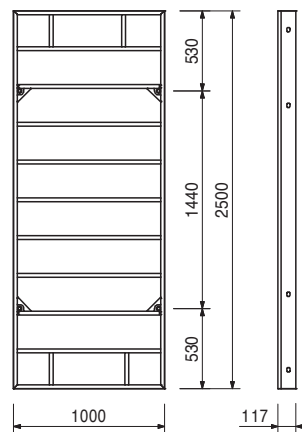
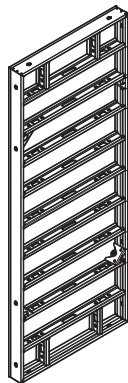

DOMINO Panel Formwork



Item no.	Weight kg
066023	47,500

Panel DA 250 x 75
Alu panel with 15 mm plywood.

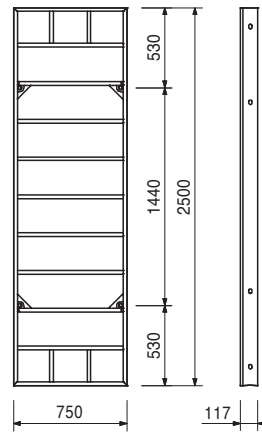
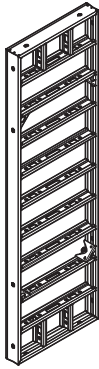

066024	76,500
066032	50,200

Multi Panels DM/DMA 250
Multi Panel DM 250 x 75
Multi Panel Alu DMA 250 x 75
Steel/alu panel with 15 mm plywood. For oblique angles, wall connections etc.

Complete with
46 pc. 030290 Plug Ø 20 mm.

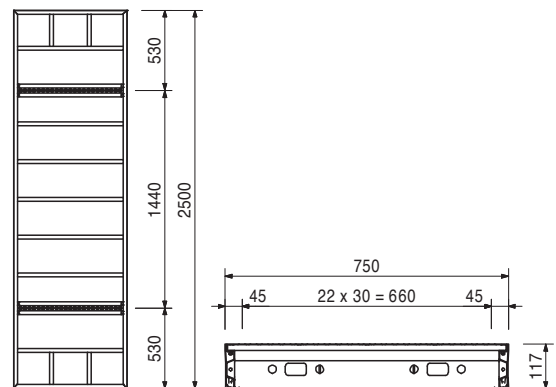
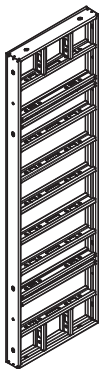

126242	67,200
--------	--------

Inside Steel Corner DISE 250
For 90° internal corners.

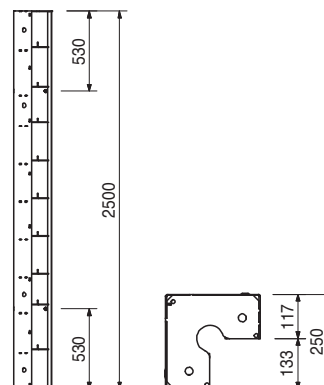

DOMINO Panel Formwork



Item no.	Weight kg
066029	40,600

Articulated Corner DGE 250

Alu panel with aluminium formlining. For oblique angles from 75°, can be used internally and externally.

Complete with

2 pc. 066100 Positioning DEA 90°.

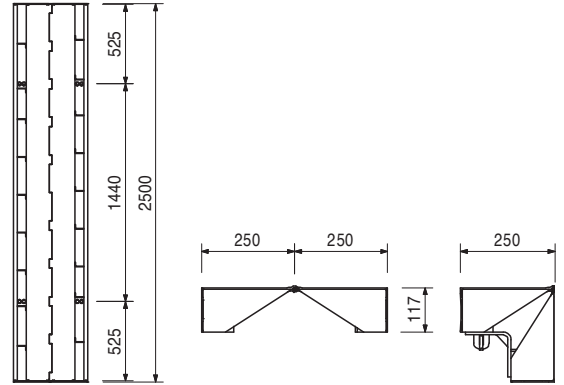

066030	7,820
101986	11,600

Wall Thickness Comp. DWD 250

Wall Thickness Comp. DWD 250 x 5

Wall Thickness Comp. DWD 250 x 10

For adjusting to wall thicknesses.

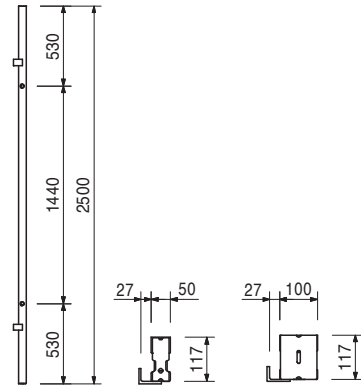

066028	10,500
--------	--------

Outside Corner Angle DAW 250

For panel connections at 90° external corners.

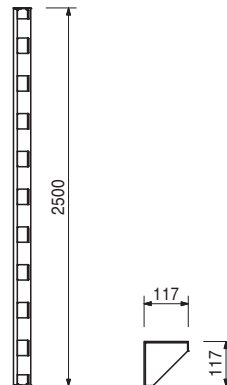

Item no.	Weight kg
066033	4,150

Filler Support DPA 250

For compensation with 21 mm filler plates.

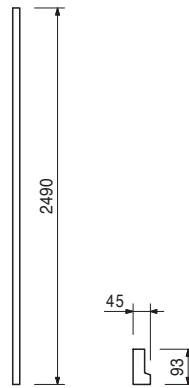

111603	148,000
--------	---------

Shaft Element DSE 275

Element for moving complete internal shaft formwork.

Technical Data

Permissible load-bearing point capacity 2.0 t.

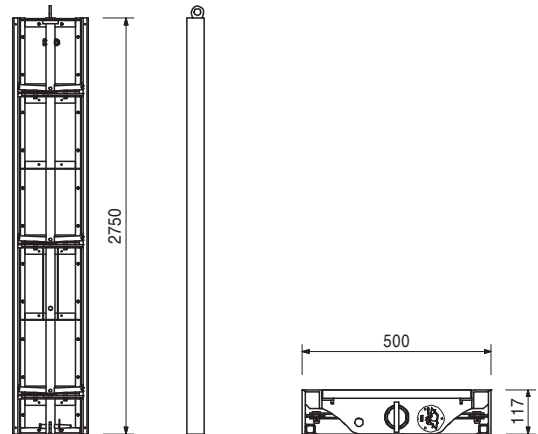

Accessories

111665	4,360
--------	-------

Spindle Shaft Element DSE

111665	4,360
--------	-------

Spindle Shaft Element DSE

For use with internal Shaft Panel DSE. For spindling back to the starting position. 1 piece per Shaft Panel DSE.

Complete with

2 pc. 105822 Bolt \varnothing 20 x 102, galv.

2 pc. 022230 Cotter Pin 5/1, galv.

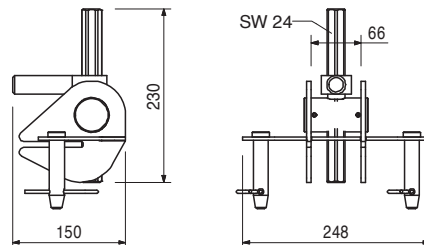
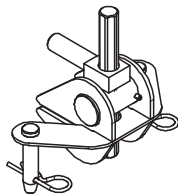

DOMINO Panel Formwork



Item no. Weight kg

101927	16,200	Stopend Panels DOMINO AT
108855	17,900	Stopend Panel DOMINO AT 250 x 3 Stopend Panel DOMINO AT 250 x 5

External unit for stopend formwork.

Note
Concrete cover approx. 30 or 50 mm.

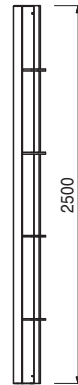

AT 250 x 3

AT 250 x 5

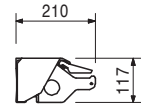
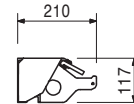

101928	27,100	Stopend Panels DOMINO MTF 250
101929	31,200	Stopend Panel DOMINO MTF 250 x 20
101930	36,000	Stopend Panel DOMINO MTF 250 x 24/25
101931	39,700	Stopend Panel DOMINO MTF 250 x 30 Stopend Panel DOMINO MTF 250 x 35/36

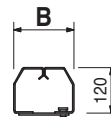
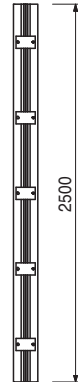

B
118
158
218
268

Center section with waterstop bar installation for stopend formwork.

124498	56,500	Panel D 150 x 100
--------	--------	--------------------------

Steel panel with 15 mm plywood.

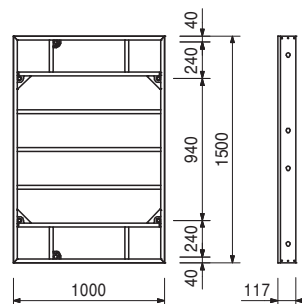
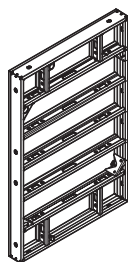

DOMINO Panel Formwork

Item no.	Weight kg
124504	46,100

Panel D 150 x 75
Steel panel with 15 mm plywood.

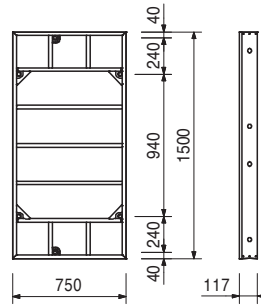

124510	34,200
--------	--------

Panel D 150 x 50
Steel panel with 15 mm plywood.

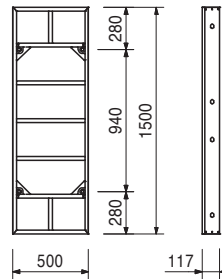

124517	26,800
--------	--------

Panel D 150 x 35
Steel panel with 15 mm plywood.

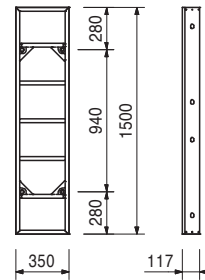

124523	22,700
--------	--------

Panel D 150 x 25
Steel panel with 15 mm plywood.

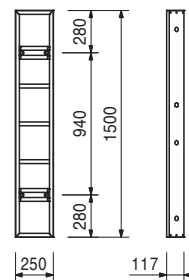

DOMINO Panel Formwork



Item no.	Weight kg
124538	51,300

Multi Panel DM 150 x 75

Steel panel with 15 mm plywood. For oblique angles, wall connections etc.

Complete with

46 pc. 030290 Plug Ø 20 mm.

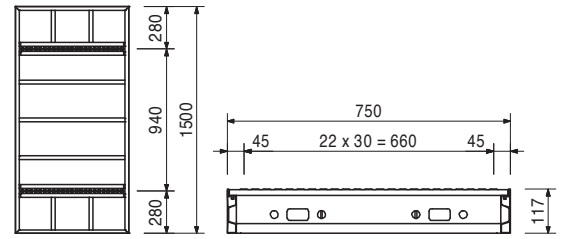

126286	40,800
--------	--------

Inside Steel Corner DISE 150

For 90° internal corners.

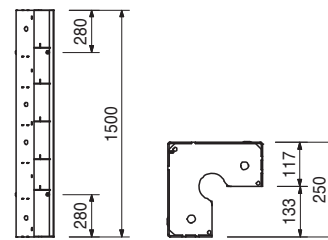

124605	23,700
--------	--------

Articulated Corner DGE 150

Alu panel with aluminium formlining. For oblique angles from 75°, can be used internally and externally.

Complete with

1 pc. 066100 Positioning DEA 90°.

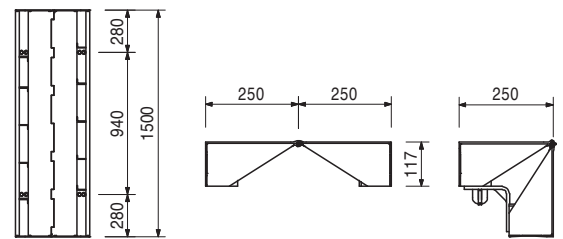

124608	6,490
--------	-------

Outside Corner Angle DAW 150

For panel connections at 90° external corners.

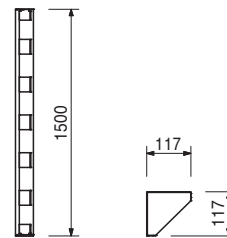

DOMINO Panel Formwork



Item no.	Weight kg	
125944	4,790	Wall Thickness Comp. DWD 150
125660	7,060	Wall Thickness Comp. DWD 150/5 Wall Thickness Comp. DWD 150/10 For adjusting to wall thicknesses.

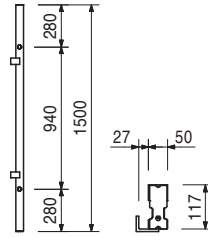

124577	2,480	Filler Support DPA 150 For compensation with 21 mm filler plates.
--------	-------	---

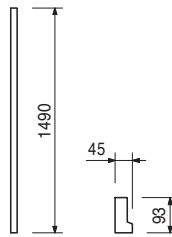

066040	47,300	Panel D 125 x 100 Steel panel with 15 mm plywood.
--------	--------	---

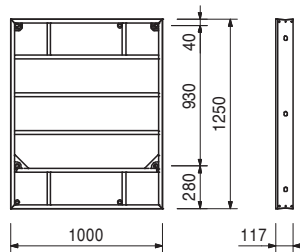
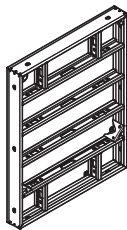

066041	38,700	Panel D 125 x 75 Steel panel with 15 mm plywood.
--------	--------	--

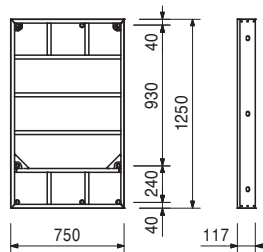
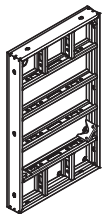

DOMINO Panel Formwork

Item no. Weight kg

066043 28,600

Panel D 125 x 50

Steel panel with 15 mm plywood.

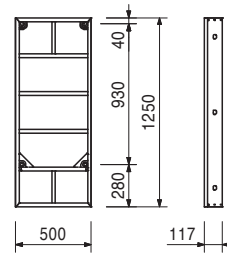

125494 22,400

Panel D 125 x 35

Steel panel with 15 mm plywood.

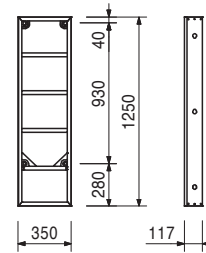

066044 18,600

Panel D 125 x 25

Steel panel with 15 mm plywood.

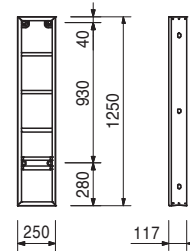

066050 31,000

Panel DA 125 x 100

Alu panel with 15 mm plywood.

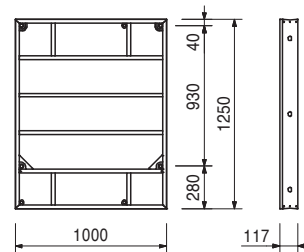
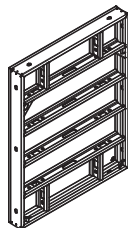

DOMINO Panel Formwork



Item no.	Weight kg
066051	24,800

Panel DA 125 x 75
Alu panel with 15 mm plywood.

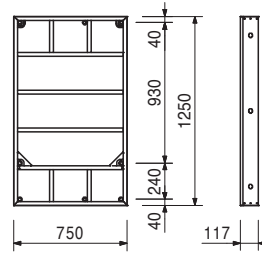
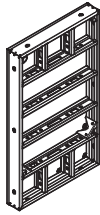

066042	43,700
066052	27,300

Multi Panels DM/DMA 125
Multi Panel DM 125 x 75
Multi Panel DMA 125 x 75
Steel/alu panel with 15 mm plywood. For oblique angles, wall connections etc.

Complete with
46 pc. 030290 Plug Ø 20 mm.

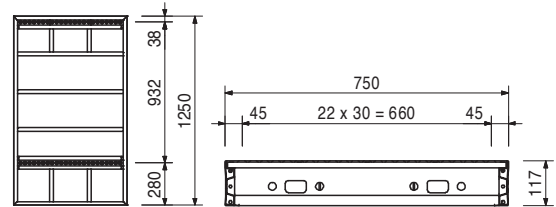
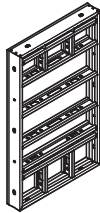

126280	34,200
--------	--------

Inside Steel Corner DISE 125
For 90° internal corners.

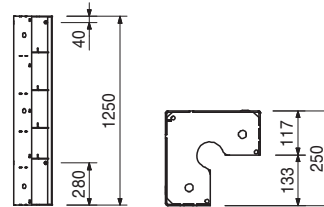

066047	21,300
--------	--------

Articulated Corner DGE 125
Alu panel with aluminium formlining. For oblique angles from 75°, can be used internally and externally.

Complete with
1 pc. 066100 Positioning DEA 90°.

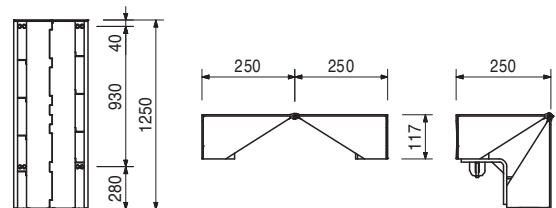

Item no. Weight kg

		Wall Thickness Comp. DWD 125
066048	4,030	Wall Thickness Comp. DWD 125 x 5
101964	5,940	Wall Thickness Comp. DWD 125 x 10

For adjusting to wall thicknesses.

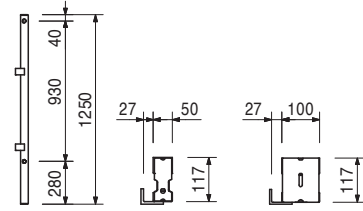

066046	5,490	Outside Corner Angle DAW 125 For panel connections at 90° external corners.
--------	-------	---

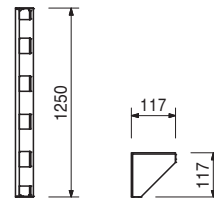

066053	2,070	Filler Support DPA 125 For compensation with 21mm filler plates.
--------	-------	--

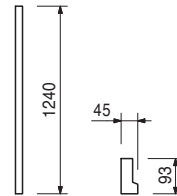

111655	77,100	Shaft Panel DSE 125 Element for moving complete internal shaft formwork.
--------	--------	--

Technical Data
Permissible load-bearing point capacity 2.0 t.

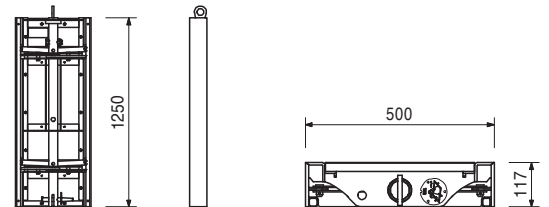

111665	4,360	Accessories Spindle Shaft Element DSE
--------	-------	---

DOMINO Panel Formwork



Item no. Weight kg

101934	8,140	Stopend Panels DOMINO AT 125
101934	8,140	Stopend Panel DOMINO AT 125 x 3
108856	8,980	Stopend Panel DOMINO AT 125 x 5

External piece for stopend formwork.

Note
Concrete cover approx. 30 or 50 mm.

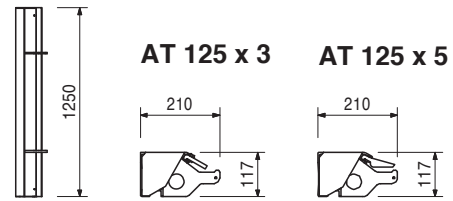

101935	14,600	Stopend Panels DOMINO MTF 125
101935	14,600	Stopend Panel DOMINO MTF 125 x 20
101936	15,200	Stopend Panel DOMINO MTF 125 x 24/25
101937	17,500	Stopend Panel DOMINO MTF 125 x 30
101940	19,300	Stopend Panel DOMINO MTF 125 x 35/36

With waterstop bar installation support for stopend formwork.

B

118
158
218
268

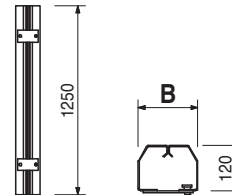

066064	12,100	Panel D 75 x 25 Steel panel with 15 mm plywood.
--------	--------	---

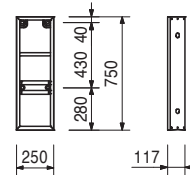

125486	14,500	Panel D 75 x 35 Steel panel with 15 mm plywood.
--------	--------	---

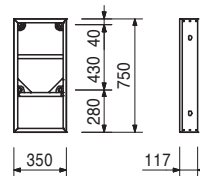

066063	19,300	Panel D 75 x 50 Steel panel with 15 mm plywood.
--------	--------	---

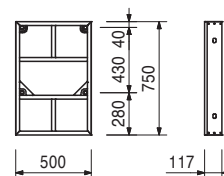

DOMINO Panel Formwork



Item no.	Weight kg	
066061	26,500	Panel D 75 x 75

Steel panel with 15 mm plywood.

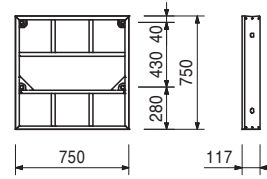
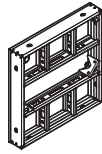

066060	32,400	Panel D 75 x 100
--------	--------	-------------------------

Steel panel with 15 mm plywood.

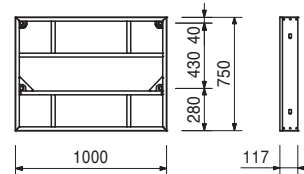
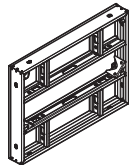

066062	31,600	Multi Panel DM 75 x 75	Complete with
--------	--------	-------------------------------	----------------------

Steel panel with 15 mm plywood. For oblique angles, wall connections, stopends etc.

46 pc. 030290 Plug Ø 20 mm.

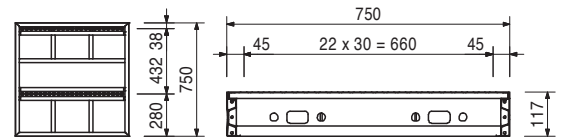
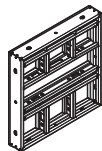

126274	21,000	Inside Steel Corner DISE 75
--------	--------	------------------------------------

For 90° internal corners.

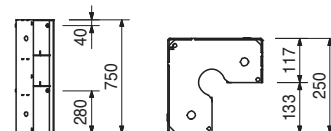

066067	14,200	Articulated Corner DGE 75	Complete with
--------	--------	----------------------------------	----------------------

Alu panel with aluminium formlining. For oblique angles from 75°, can be used internally and externally.

1 pc. 066100 Positioning DEA 90°.

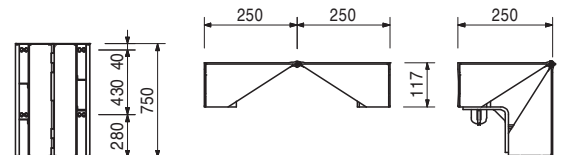

Item no.	Weight kg
066068	2,520

Wall Thickness Compensation DWD 75 x 5
For adjusting to wall thicknesses.

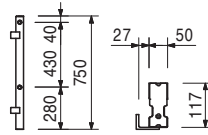

066066	3,500
--------	-------

Outside Corner Angle DAW 75
For panel connections at 90° external corners.

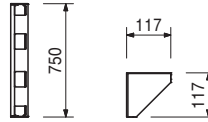

066080	3,940
--------	-------

Alignment Coupler DRS
For all panel connections for DOMINO. Fillers up to 12 cm.

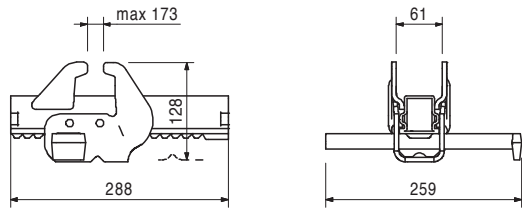
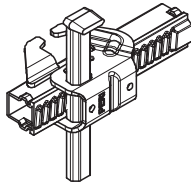

066081	1,160
--------	-------

Wedge Clamp DKS
For panel connections without high loads with DOMINO.

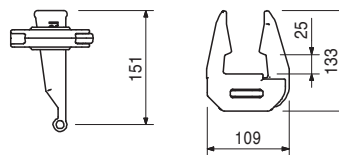
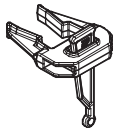

066084	8,510
--------	-------

Compensation Waler DAR 80
For longitudinal compensation, height extensions, stopend formwork and special applications with DOMINO. With captive connecting components.

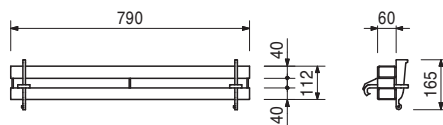
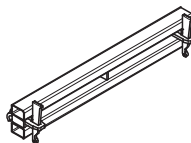

DOMINO Panel Formwork



Item no.	Weight kg
110406	2,100

Stopend Tie-2 DSA

For force application from the stopend formwork into DOMINO panels. DW 15 thread.

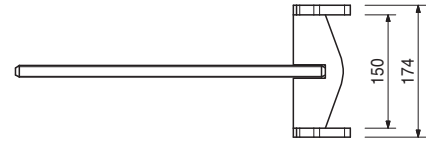
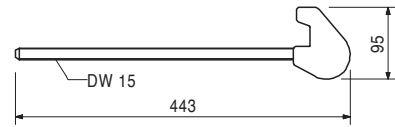
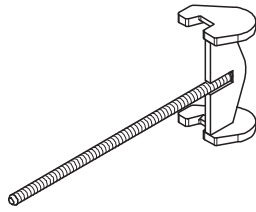

127010	8,710
--------	-------

Push-Pull Spreader DOMINO 15 – 100

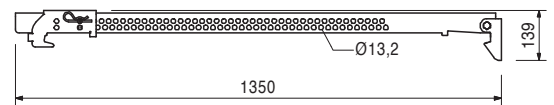
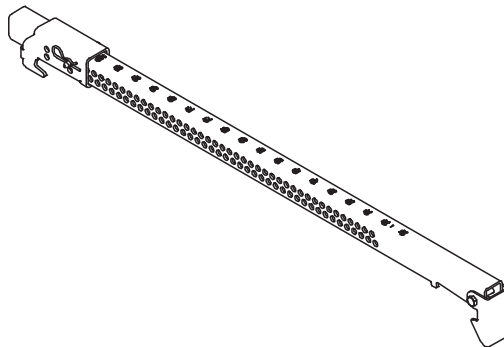

030290	0,002
--------	-------

Plug Ø 20 mm

For closing Ø 20 mm tie holes which are not required.

Note

Delivery unit 500 pieces.

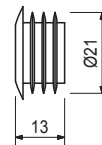

066088	2,030
--------	-------

DOMINO Chamfer Strip DSD 250

For DOMINO Column Formwork and outside corners.

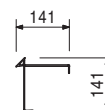

Item no.	Weight kg		
----------	-----------	--	--

066086 1,110

Top Tie Bracket DAH

For grid-independent anchoring outside of the panel, especially for foundations.

Technical Data

Permissible anchor tensile force:
Hole 1 = 20 kN
Hole 2 = 10 kN

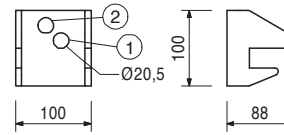
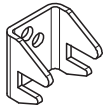

066100 1,470

Positioning DEA 90°

For 90° internal corners.

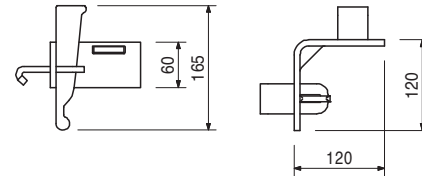
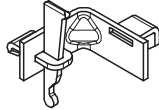

066095 1,060

Positioning DGE 135° internal

For 135° internal corners.

Complete with

2 pc. 710224 Bolt ISO 4017 M12 x 40-8.8, galv.

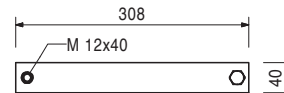
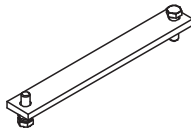

066097 1,560

Positioning DGE 135° external

For 135° external corners.

Complete with

2 pc. 710224 Bolt ISO 4017 M12 x 40-8.8, galv.

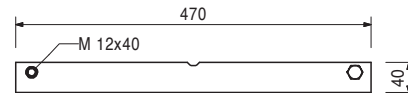
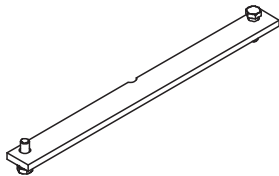

111665 4,360

Spindle Shaft Element DSE

For use with internal Shaft Panel DSE. For spindling back to the starting position. 1 piece per Shaft Panel DSE.

Complete with

2 pc. 105822 Bolt Ø 20 x 102, galv.
2 pc. 022230 Cotter Pin 5/1, galv.

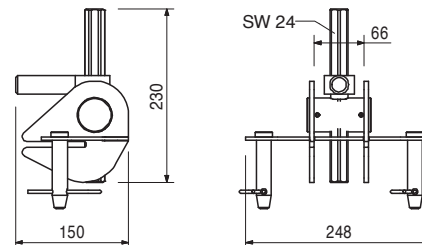
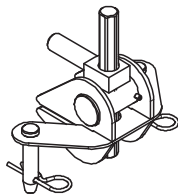

Item no.	Weight kg
066085	6,970

Scaffold Bracket DG 85

For assembly of a working and concreting scaffold with DOMINO.

Technical Data

Permissible load 150 kg/m² with maximum width of influence 2.00 m.

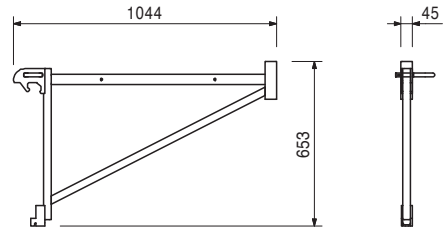
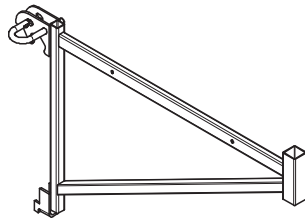

Accessories

116292	4,730
--------	-------

Guardrail Post HSGP-2

106877	2,730
--------	-------

Guardrail Post Holder DOMINO

For assembling a guardrail to DOMINO panels.

Complete with

1 pc. 018060 Cotter Pin 4/1, galv.

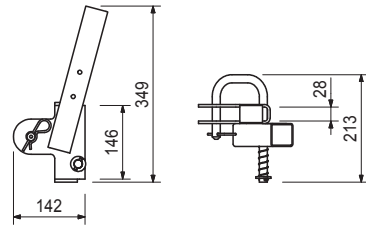

Accessories

116292	4,730
--------	-------

Guardrail Post HSGP-2

116292	4,730
--------	-------

Guardrail Post HSGP-2

As guardrail for different systems.

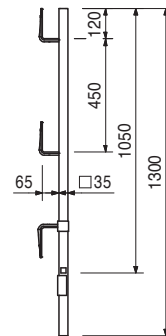

066091	6,330
--------	-------

Lifting Hook DOMINO 500 kg

For transporting DOMINO panels.

Note

Follow Instructions for Use!

Technical Data

Permissible load-bearing capacity 500 kg.

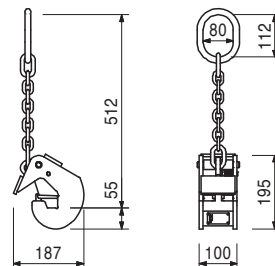

Item no.	Weight kg
066094	8,040

Stacking Device DOMINO DSR, galv.

For stacking and transportation of 2 – 8 DOMINO panels of all sizes. Suitable for crane and fork-lift transport. 4 pieces per stack.

Note

Follow Instructions for Use!

Technical Data

Permissible load-bearing capacity 250 kg per piece, 1 t per stack.

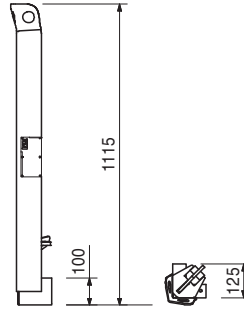

066093	0,020
--------	-------

Stacking Aid DOMINO DSH

Plastic. Prevents the panel from sliding sideways.

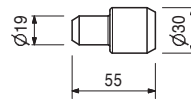

066099	0,030
--------	-------

Stacking Aid DOMINO DSW

For stacking DOMINO panels. 4 panels per stack.

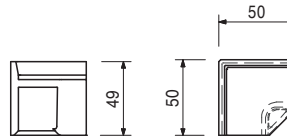
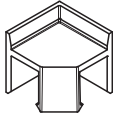

Item no.	Weight kg
027680	49,600

Connector SB-1, 2 – MX/TR/D

For assembly of Brace Frame SB-1, 2 to MAXIMO, TRIO and DOMINO panels.

Technical Data

Permissible load-bearing point capacity 1.0 t with crane sling angle $\leq 15^\circ$.

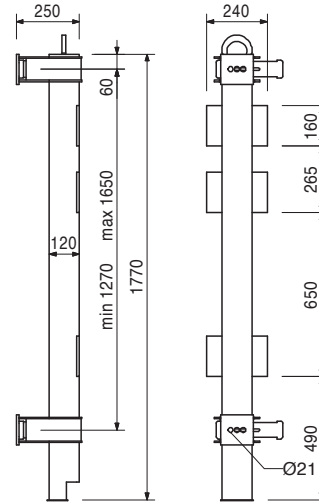
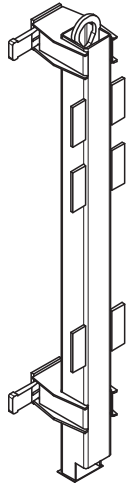

Accessories

027690	0,368	Bolt SB-TRIO/DOMINO, galv.
027590	2,400	Hook Strap for SB-1, 2, galv.
113255	0,414	Bolt SB-MAXIMO, galv.
114107	1,190	Sleeve SB-MAXIMO, galv.
114417	1,400	Sleeve SB-MAXIMO WDMX

025740	9,140
--------	-------

Connector SB-A, B, C – MX/TR/D

For connecting MAXIMO, TRIO and DOMINO panels with Brace Frames SB-A0, A, B, C.

Note

1 piece per anchor point.

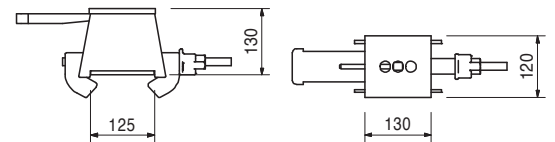
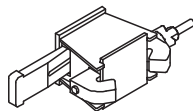

Accessories

027690	0,368	Bolt SB-TRIO/DOMINO, galv.
113255	0,414	Bolt SB-MAXIMO, galv.
114107	1,190	Sleeve SB-MAXIMO, galv.
114417	1,400	Sleeve SB-MAXIMO WDMX

027690	0,368
--------	-------

Bolt SB-TRIO/DOMINO, galv.

For panel formwork with 12 cm overall thickness.

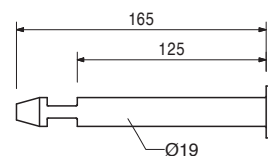
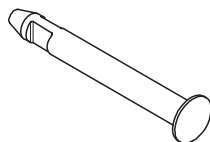

Accessories

114107	1,190	Sleeve SB-MAXIMO, galv.
114417	1,400	Sleeve SB-MAXIMO WDMX

Item no.	Weight kg
066090	2,480

Foundation Tie Clamp DOMINO DLS

For anchoring foundation formwork in combination with the Perforated Foundation Tie.

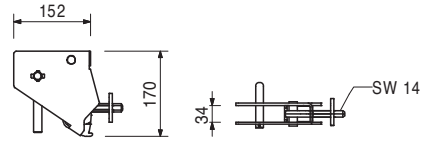
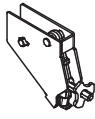

023020	0,676
--------	-------

Perforated Foundation Tie, 25 m

For use with Foundation Tie Clamp TRIO, DOMINO and HANDSET.

Technical Data

Permissible tension force 12.9 kN.

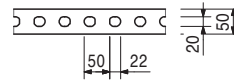

066082	1,040
--------	-------

Brace Connector DRA

For connecting push pull props and kicker braces at DOMINO panels.

Complete with

1 pc. 027170 Pin \varnothing 16 x 42, galv.
1 pc. 018060 Cotter Pin 4/1, galv.

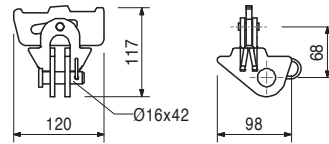
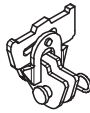

117466	10,600
--------	--------

Push-Pull Prop RS 210, galv.

Extension length L = 1.30 – 2.10 m.
For aligning PERI formwork systems and precast concrete elements.

Note

Permissible load see PERI Design Tables.

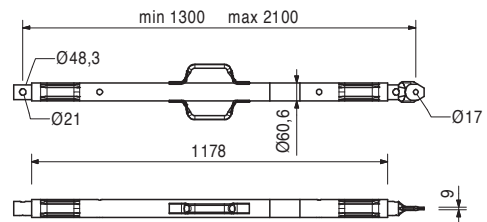
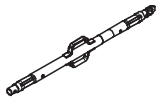

118238	12,200
--------	--------

Push-Pull Prop RS 260, galv.

Extension length L = 2.30 – 2.60 m.
For aligning PERI formwork systems and precast concrete elements.

Note

Permissible load see PERI Design Tables.

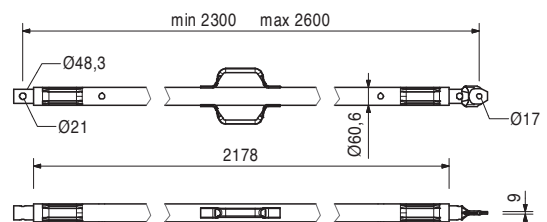
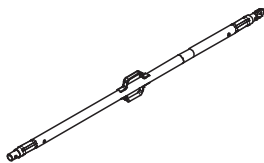

DOMINO Panel Formwork



Item no.	Weight kg
117467	15,500

Push-Pull Prop RS 300, galv.

Extension length $l = 1.90 - 3.00$ m.
For aligning PERI formwork systems and precast concrete elements.

Note

Permissible load see PERI Design Tables.

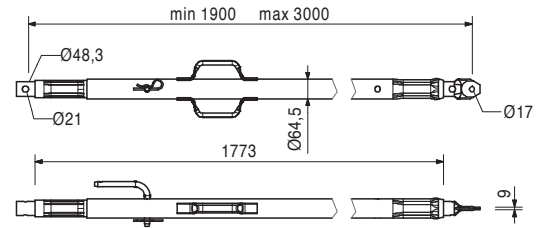
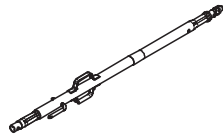

117468	23,000
--------	--------

Push-Pull Prop RS 450, galv.

Extension length $L = 2.80 - 4.50$ m.
For aligning PERI formwork systems and precast concrete elements.

Note

Permissible load see PERI Design Tables.

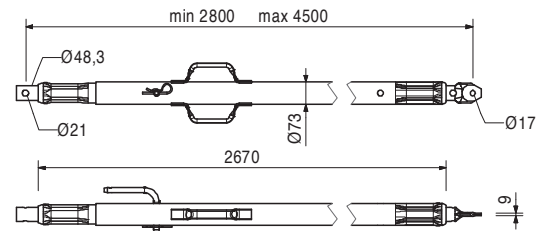
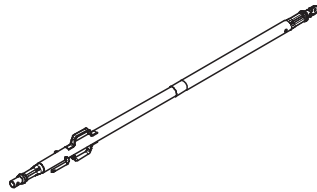

117469	40,000
--------	--------

Push-Pull Prop RS 650, galv.

Extension length $L = 4.30 - 6.50$ m.
For aligning PERI formwork systems and precast concrete elements.

Note

Permissible load see PERI Design Tables.

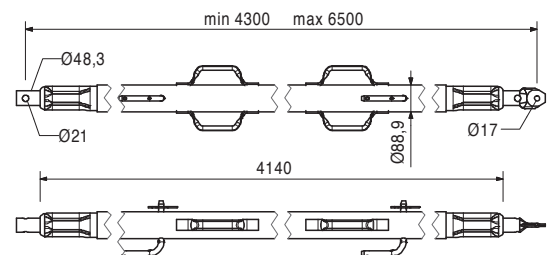
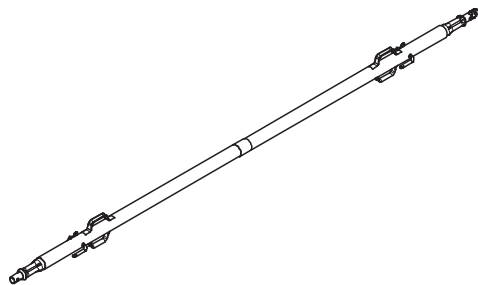

028990	115,000
--------	---------

Push-Pull Prop RS 1000, galv.

Extension length $L = 6.40 - 10.00$ m.
For aligning PERI formwork systems.

Note

Permissible load see PERI Design Tables.

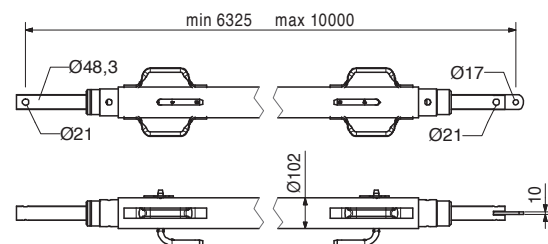
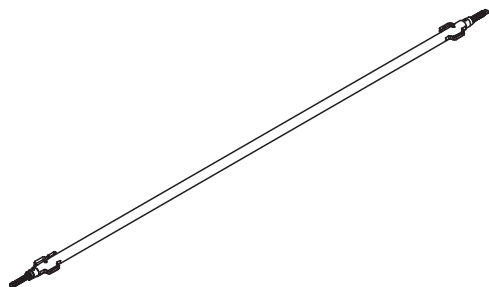

DOMINO Panel Formwork



Item no.	Weight kg
103800	271,000

Push-Pull Prop RS 1400, galv.
 Extension length L = 6.40 – 14.00 m.
 For aligning PERI formwork systems.

Note
 Permissible load see PERI Design Tables.
 Chain can be operated from bottom.

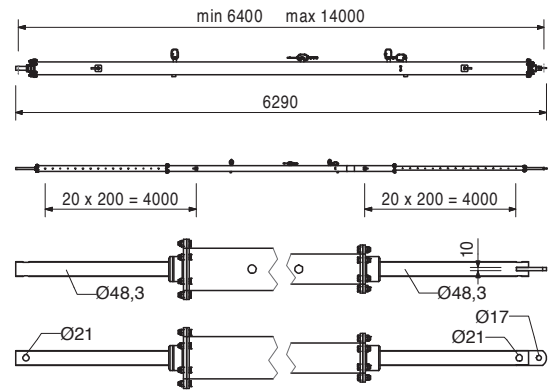
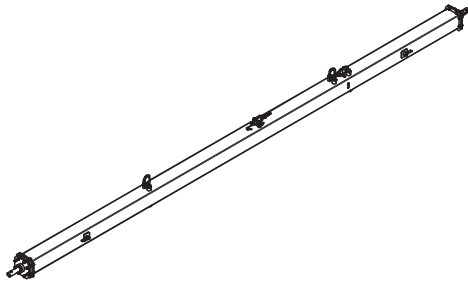

117343	3,250
--------	-------

Base Plate-2 for RS 210 – 1400, galv.
 For assembly of Push-Pull Props RS 210, 260, 300, 450, 650, 1000 and 1400.

Complete with
 2 pc. 105400 Pin Ø 20 x 140, galv.
 2 pc. 018060 Cotter Pin 4/1, galv.

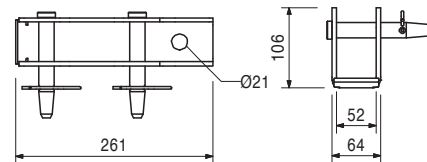
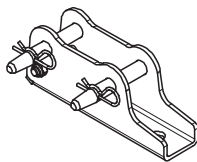

124777	0,210
--------	-------

Accessories
Anchor Bolt PERI 14/20 x 130

028010	17,900
--------	--------

Push-Pull Prop RSS I
 Extension length L = 2.05 – 2.94 m.
 For aligning PERI formwork systems.

Note
 Permissible load see PERI Design Tables.

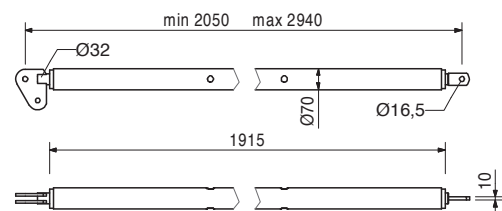
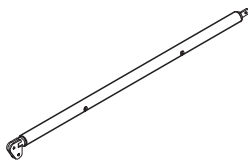

113397	1,600
--------	-------

Spindle Handle RSS / AV

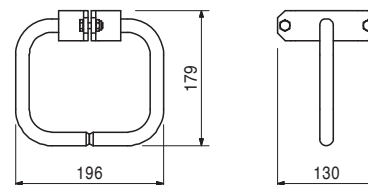
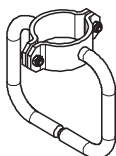

DOMINO Panel Formwork



Item no.	Weight kg
028020	22,000

Push-Pull Prop RSS II

Extension length L = 2.91 – 3.80 m.
For aligning PERI formwork systems.

Note

Permissible load see PERI Design Tables.

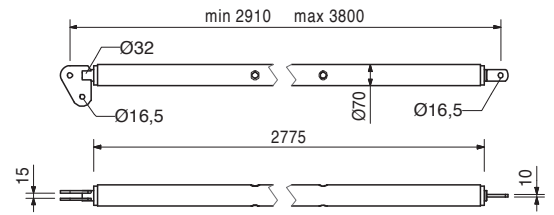
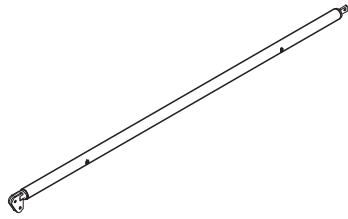

028030	38,400
--------	--------

Push-Pull Prop RSS III

Extension length L = 4.60 – 6.00 m.
For aligning PERI formwork systems.

Note

Permissible load see PERI Design Tables.

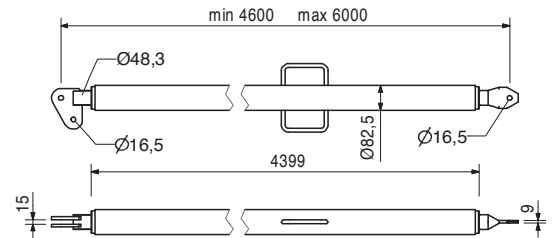
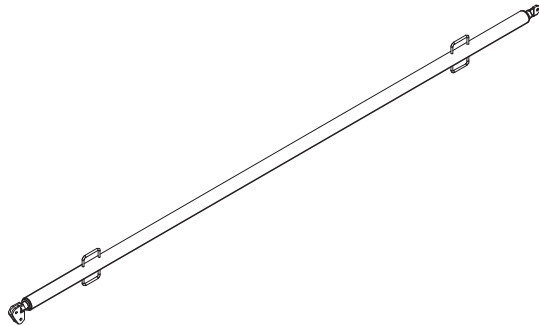

106000	1,820
--------	-------

Base Plate-2 for RSS, galv.

For assembly of RSS Push-Pull Props.

Complete with

1 pc. 027170 Pin Ø 16 x 42, galv.
1 pc. 018060 Cotter Pin 4/1, galv.

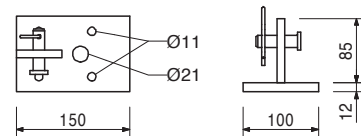
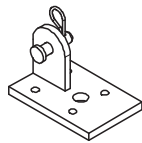

Accessories

124777	0,210
--------	-------

Anchor Bolt PERI 14/20 x 130

DOMINO Panel Formwork



Item no. Weight kg

057087	3,720
057088	4,410

Kickers AV

Kicker AV 82

Kicker AV 111

For aligning PERI formwork systems.

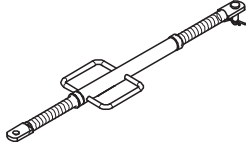

min. L max. L

500	820
790	1110

Complete with

1 pc. 027170 Pin Ø 16 x 42, galv.

1 pc. 018060 Cotter Pin 4/1, galv.

Note

Permissible load see PERI Design Tables.

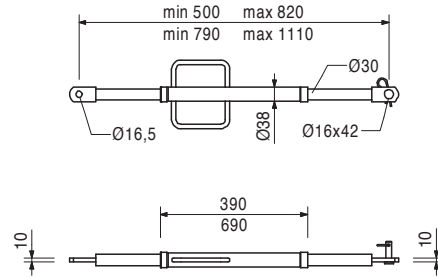

028110 5,180

Kicker AV 140

Extension length L = 1.08 – 1.40 m.

For aligning PERI formwork systems.

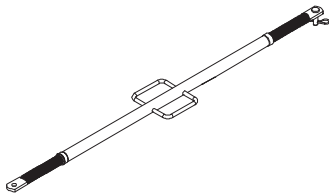

Complete with

1 pc. 027170 Pin Ø 16 x 42, galv.

1 pc. 018060 Cotter Pin 4/1, galv.

Note

Permissible load see PERI Design Tables.

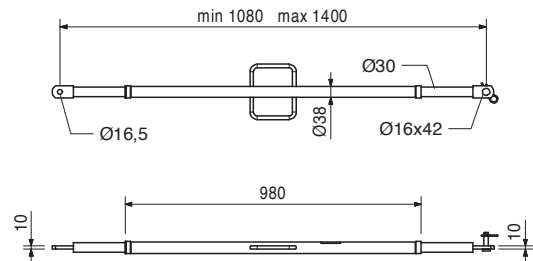

108135 12,900

Kicker AV 210

Extension length L = 1.28 – 2.10 m.

For aligning PERI formwork systems.

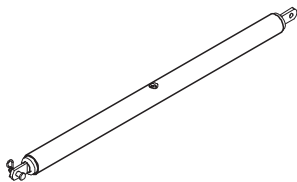

Complete with

1 pc. 027170 Pin Ø 16 x 42, galv.

1 pc. 018060 Cotter Pin 4/1, galv.

Note

Permissible load see PERI Design Tables.

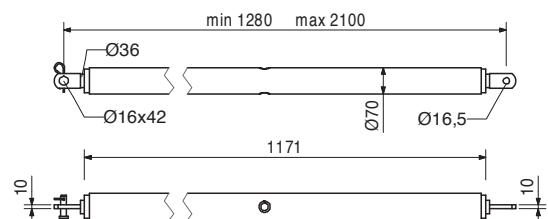

Item no.	Weight kg
028120	17,000

Kicker AV RSS III

Extension length L = 2.03 – 2.92 m.
For aligning PERI formwork systems.

Complete with

1 pc. 027170 Pin Ø 16 x 42, galv.
1 pc. 018060 Cotter Pin 4/1, galv.

Note

Permissible load see PERI Design Tables.

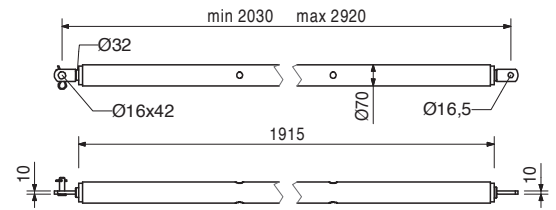
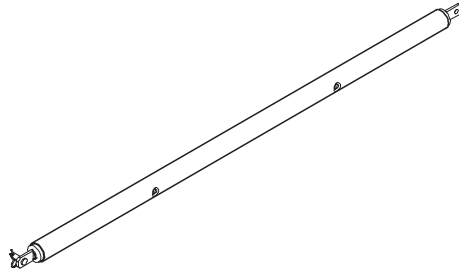

124777	0,210
--------	-------

Anchor Bolt PERI 14/20 x 130

For temporary fixation to reinforced concrete structures.

Note

See PERI data sheet!
Drilling Ø 14 mm.

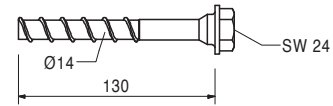
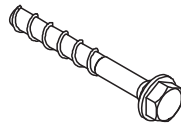

PERI International

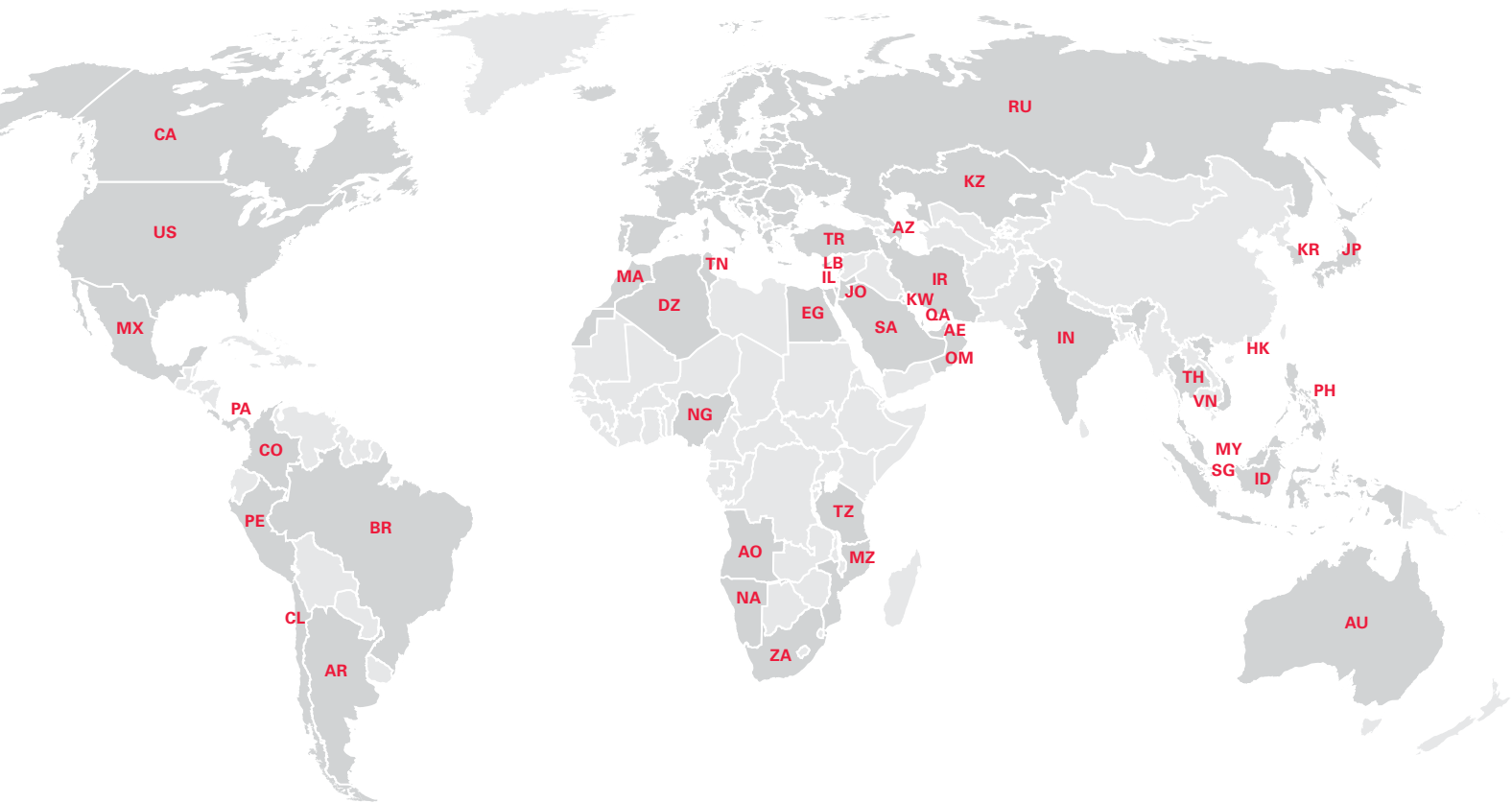

North America

- CA** Canada
PERI Formwork Systems, Inc.
www.peri.ca
- MX** Mexico
PERI Cimbras y Andamios, S.A. de C.V.
www.peri.com.mx
- PA** Panama
PERI Panama Inc.
www.peri.com.pa
- US** USA
PERI Formwork Systems, Inc.
www.peri-usa.com

South America

- AR** Argentina
PERI S.A.
www.peri.com.ar
- BR** Brazil
PERI Formas e Escoramentos Ltda.
www.peribrasil.com.br
- CL** Chile
PERI Chile Ltda.
www.peri.cl
- CO** Colombia
PERI S.A.S.
www.peri.com.co
- PE** Peru
PERI Peruana S.A.C.
www.peri.com.pe

Africa

- AO** Angola
Pericofragens, Lda.
www.peri.pt
- DZ** Algeria
S.A.R.L. PERI
www.peri.dz
- EG** Egypt
Egypt Branch Office
www.peri.com.eg
- MA** Morocco
PERI S.A.
www.peri.ma
- MZ** Mozambique
PERI (Pty.) Ltd.
www.peri.co.mz
- NA** Namibia
PERI (Pty.) Ltd.
www.peri.na
- NG** Nigeria
PERI Nigeria Ltd.
www.peri.ng
- TN** Tunisia
PERI S.A.U.
www.peri.es
- TZ** Tanzania
PERI Formwork and Scaffolding Ltd
www.peri.co.tz
- ZA** South Africa
PERI Formwork Scaffolding (Pty) Ltd
www.peri.co.za

Asia

- AE** United Arab Emirates
PERI (L.L.C.)
www.peri.ae
- AZ** Azerbaijan
PERI Representative Office
www.peri.com.tr
- HK** Hong Kong
PERI (Hong Kong) Limited
www.perihk.com
- ID** Indonesia
PT Beton Perkasa Wijaksana
www.betonperkasa.com
- IL** Israel
PERI F.E. Ltd.
www.peri.co.il
- IN** India
PERI (India) Pvt Ltd
www.peri.in
- IR** Iran
PERI Pars. Ltd.
www.peri.ir
- JO** Jordan
PERI GmbH – Jordan
www.peri.com
- JP** Japan
PERI Japan K.K.
www.peri.co.jp
- KR** Korea
PERI (Korea) Ltd.
www.perikorea.com
- KW** Kuwait
PERI Kuwait W.L.L.
www.peri.com.kw
- KZ** Kazakhstan
TOO PERI Kazakhstan
www.peri.kz
- LB** Lebanon
PERI Lebanon Sarl
lebanon@peri.de
- MY** Malaysia
PERI Formwork Malaysia Sdn. Bhd.
www.perimalaysia.com
- OM** Oman
PERI (L.L.C.)
www.peri.ae
- PH** Philippines
PERI-Asia Philippines, INC.
www.peri.com.ph
- QA** Qatar
PERI Qatar LLC
www.peri.qa
- SA** Saudi Arabia
PERI Saudi Arabia Ltd.
www.peri.com.sa
- SG** Singapore
PERI Asia Pte Ltd
www.periasia.com
- TH** Thailand
Peri (Thailand) Co., Ltd.
www.peri.co.th
- TR** Turkey
PERI Kalıp ve İskeleleri
www.peri.com.tr
- VN** Vietnam
PERI ASIA PTE LTD
www.peri.com.vn



PERI

PERI GmbH Formwork Scaffolding Engineering

Rudolf-Diesel-Strasse 19
89264 Weissenhorn
Germany
Tel. +49 (0)7309.950-0
Fax +49 (0)7309.951-0
info@peri.com
www.peri.com

Oceania

AU Australia
PERI Australia Pty. Ltd.
www.periaus.com.au

DK Denmark
PERI Danmark A/S
www.peri.dk

IT Italy
PERI S.r.l.
www.peri.it

SE Sweden
PERI Sverige AB
www.peri.se

Europe

EE Estonia
PERI AS
www.peri.ee

LT Lithuania
PERI UAB
www.peri.lt

SI Slovenia
PERI oplate i skele d.o.o
www.peri.com.hr

AL Albania
PERI Kalıp ve İskeleleri
www.peri.com.tr

ES Spain
PERI S.A.U.
www.peri.es

LU Luxembourg
N.V. PERI S.A.
www.peri.lu

SK Slovakia
PERI spol. s. r.o.
www.peri.sk

AT Austria
PERI Ges.mBH
www.peri.at

FI Finland
PERI Suomi Ltd. Oy
www.perisuomi.fi

LV Latvia
PERI SIA
www.peri-latvija.lv

UA Ukraine
TOW PERI
www.peri.ua

BA Bosnia and Herzegovina
PERI oplate i skele d.o.o
www.peri.com.hr

FR France
PERI S.A.S.
www.peri.fr

NL Netherlands
PERI b.v.
www.peri.nl

BE Belgium
PERI N.V.
www.peri.be

GB United Kingdom
PERI Ltd.
www.peri.ltd.uk

NO Norway
PERI Norge AS
www.peri.no

BG Bulgaria
PERI Bulgaria EOOD
www.peri.bg

GR Greece
PERI Hellas Ltd.
www.perihellas.gr

PL Poland
PERI Polska Sp. z o.o.
www.peri.com.pl

BY Belorussia
IOOO PERI
www.peri.by

HR Croatia
PERI oplate i skele d.o.o.
www.peri.com.hr

PT Portugal
Pericofragens Lda.
www.peri.pt

CH Switzerland
PERI AG
www.peri.ch

HU Hungary
PERI Kft.
www.peri.hu

RO Romania
PERI România SRL
www.peri.ro

CZ Czech Republic
PERI spol. s r.o.
www.peri.cz

IR Ireland
Siteserv Access & Formwork
www.siteservaccess.ie

RS Serbia
PERI oplate d.o.o.
www.peri.rs

DE Germany
PERI GmbH
www.peri.de

IS Iceland
Armar ehf.
www.armor.is

RU Russia
OOO PERI
www.peri.ru

**The optimal System
for every Project and
every Requirement**



Wall Formwork



Column Formwork



Slab Formwork



Climbing Systems



Bridge Formwork



Tunnel Formwork



Shoring Systems



Construction Scaffold



Facade Scaffold



Industrial Scaffold



Access



Protection Scaffold



Safety Systems



**System-Independent
Accessories**



Services



PERI GmbH
Formwork Scaffolding Engineering
 Rudolf-Diesel-Strasse 19
 89264 Weissenhorn
 Germany
 Tel. +49 (0)7309.950-0
 Fax +49 (0)7309.951-0
 info@peri.com
 www.peri.com

