

PD 5 Shoring System

Simultaneous support of slabs and beams

Product Brochure – Issue 02/2020



Content

System advantages

- 5 PD 5 Shoring System**
Simultaneous support of slabs and beams
- 6 Maximum flexibility of use**
Quick and continuous height adjustment with only two frame sizes
- 8 Quick assembly**
Clever details and only a small number of individual parts
- 10 Quick assembly**
Basic assembly and assembly of additional levels
- 11 Quick assembly**
Assembly of head areas
- 13 Simple and safe handling**
Low component weight and sophisticated frame design

System overview

- 14 PD 5 Shoring System at a glance**

Issue 02/2020

Publisher

PERI GmbH
Formwork Scaffolding Engineering
Rudolf-Diesel-Straße 19
89264 Weissenhorn
Germany
info@peri.com
www.peri.com

Project example

16 PD 5 Shoring System in use

500 West Trade, Charlotte,
North Carolina, USA

Important notes

All current safety regulations and guidelines applicable in those countries where our products are used must be observed.

The photos shown in this brochure feature construction sites in progress. For this reason, safety and anchor details in particular cannot always be considered conclusive or final. These are subject to the risk assessment carried out by the contractor.

In addition, the computer graphics used are to be regarded as system representations. To facilitate understanding, these and the detailed illustrations shown have been partially reduced to certain

aspects. The safety installations that are not shown in these detailed descriptions must nevertheless be available. The systems or items shown might not be available in every country.

Safety instructions and load specifications are to be strictly observed at all times. Separate structural calculations are required for any deviations from the standard design data.

The information contained herein is subject to technical changes in the interests of progress. Errors and typographical mistakes reserved.



PD 5 Shoring System

Simultaneous support of slabs and beams

PD 5 is predestined for the use as a shoring system in the medium load-bearing capacity range up to 55 kN per leg. The powder-coated frame system particularly demonstrates its benefits in combination with slab formwork with VT 20 or GT 24 girders and beams.

The height of the PD 5 Shoring System can be adjusted continuously for shoring towers and slab tables on account of the sophisticated supporting frame construction. Its carefully considered details, small number of individual components, and low weight ensure safe assembly. Beams can also be realised in no time with just a few additional components.

The components are adapted to suit the system grid of the PERI UP modular construction kit, allowing you to integrate decking or ledgers from PERI UP Flex.

What's more, it is even possible to achieve a load-bearing capacity of up to 47.2 kN per leg even at a height of 9.65 m and a total spindle extension of 0.65 m. Thus, the number of required shoring towers is minimised depending on the structural conditions. You can save material on your construction site.

Assembly and dismantling work can take place either vertically or horizontally. You can even transport the system safely by crane or on a trolley with winch unit.



Maximum flexibility of use
thanks to quick and continuous height adjustment with only two frame sizes.



Quick assembly
thanks to clever details and only a small number of individual parts.



Simple and safe handling
on account of a low component weight and the sophisticated frame design.

Maximum flexibility of use

Quick and continuous height adjustment with only two frame sizes

The PD 5 shoring system consists of a low number of system components: The main components include two frames, head and base spindles as well as diagonal braces.

You can use the PD 5 shoring with various frame combinations and diagonal braces at different heights in various ground plans with easy geometric adaptation for many projects.

With only two frame heights (100 cm and 150 cm) and a spindle adjustment of up to 102 cm, all heights can be continuously adjusted.

In addition, PD 5 diagonal braces in dimensions of 150 cm, 200 cm and 250 cm ensure optimal ground plan adjustments in the longitudinal direction of the shoring tower.

Frame shoring system made of welded, powder-coated tubular steel elements with spindles at the head and base

Basic dimensions: 1.25 m x 1.50 m / 1.25 m x 2.00 m / 1.25 m x 2.50 m

Continuous height adjustment with only two frame sizes

Can be assembled vertically or horizontally

Easy horizontal and vertical moving procedure with the trolley and winch or crane



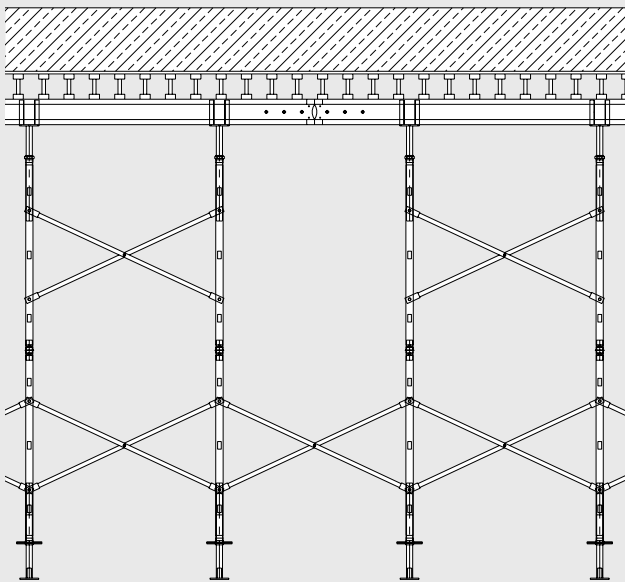

You can form individual towers without tube couplings to shoring tower segments. This secures the towers against tilting during assembly and helps to constantly maintain the spacing between the individual towers.

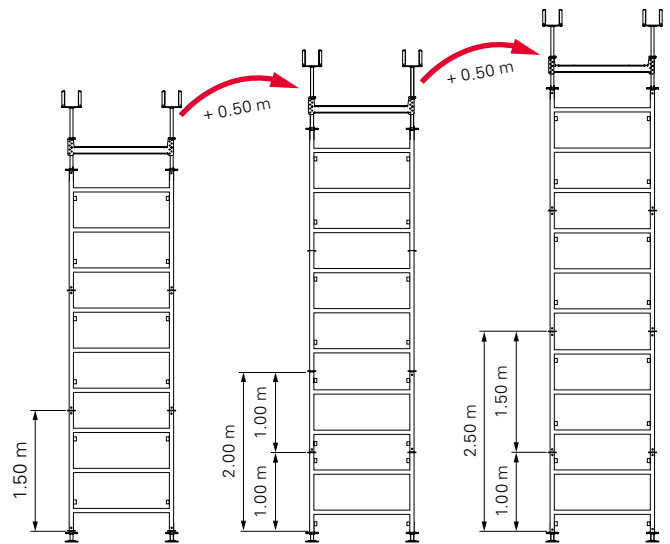
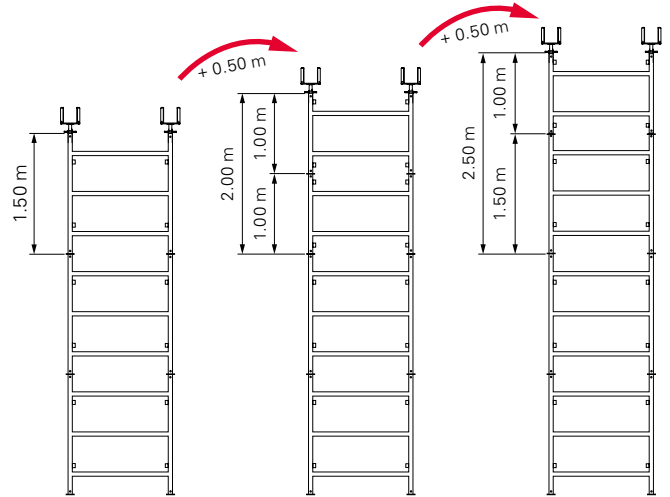

It is possible to adapt the basic dimensions using the different diagonal cross lengths. Thanks to the different frame heights and spindle adjustments, you can implement your appropriate height quickly and continuously.

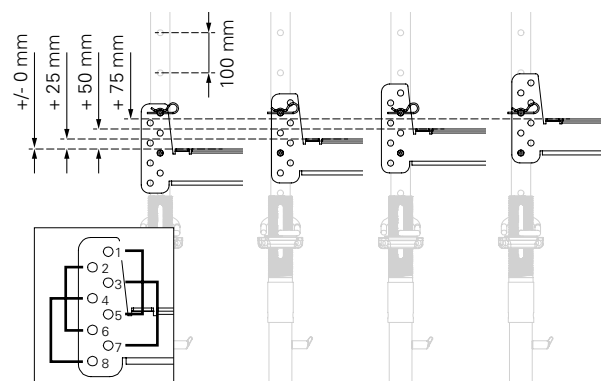

Also spindle adjustments up to 105 cm are possible using the beam spindle. Continuous adjustment can be implemented in the spindle head area, roughly in 10-cm increments and finely in 2.5-cm increments.

Quick assembly

Clever details and only a small number of individual parts

Assembly and dismantling of the PD 5 system is particularly efficient due to its simple system logic and the low number of system components.

The necessary shoring can be quickly planned and set up due to the frame system design of the PD 5 system. Therefore, you can independently implement large slab areas cost-effectively. With only three different diagonals that you can use for both frame sizes, and additionally for possibly required horizontal bracing, the set up is clear and easy to implement.

In addition, the clever details ensure a safe and fast assembly and dismantling process. The beams can be supported simultaneously. Therefore, you benefit from a complete and notably efficient solution.



The assembly of a PD 5 tower is intuitively easy to follow and carried out in a few steps.

After the first level is aligned, consisting of the base spindles, two frames and diagonals,...



...the additional frames can be easily placed on top of each other by means of couplers and secured with a double pin frame. The installation of the diagonals subsequently takes place while these are comfortably mounted from below at the top on the cam and



inserted at the bottom afterwards where the gravity finger is closed accordingly. It is therefore possible to efficiently erect the shoring to the required height and complete it using crosshead spindles or the beam solution.

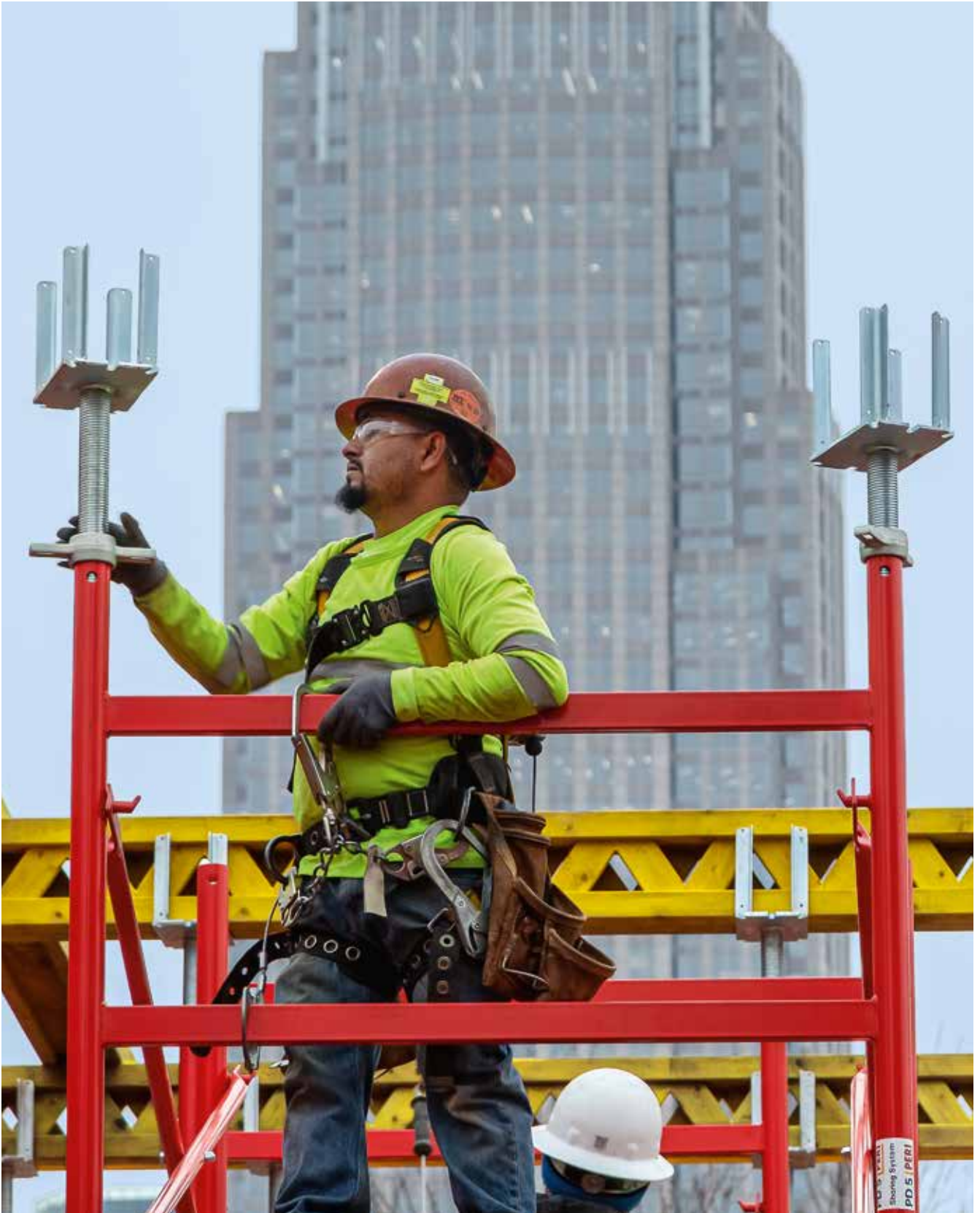

Quick assembly

Basic assembly and assembly of additional levels

Basic assembly

The PD 5 Shoring System is usually assembled vertically on an assembly area. A crane is not required for the assembly but can be used to facilitate working procedures.

After mounting the base spindles on the frame (Detail A), the frame components are set up vertically according to specification. The diagonal braces are subsequently

mounted on the top of the frame on the integrated cam and inserted at the bottom afterwards where the gravity finger is closed accordingly (Detail B).

In order to align the PD 5 frames at right angles, a horizontal diagonal brace can be mounted and fixed with screwable flip locks. Alternatively, UDG steel decks can be used. The frames can then be precisely aligned with the spindles to suit the required height.

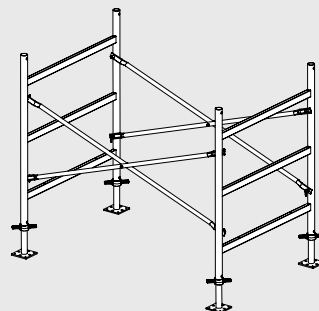

Detail A

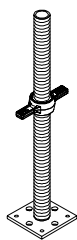

Detail B

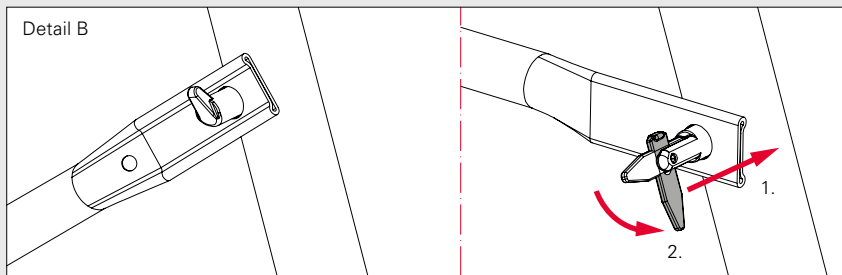

Assembly of additional levels

Additional PD 5 frames are to be assembled with the help of a working platform or previously installed decks.

The frames are tightly connected to each other by means of connectors with washers and double pin frames (see Detail C).

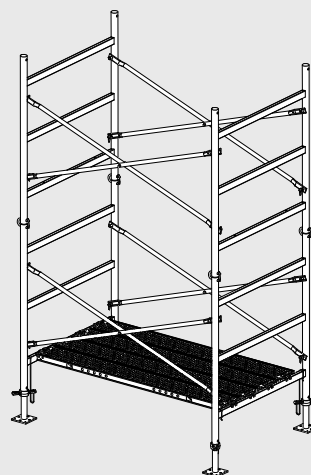

Detail C

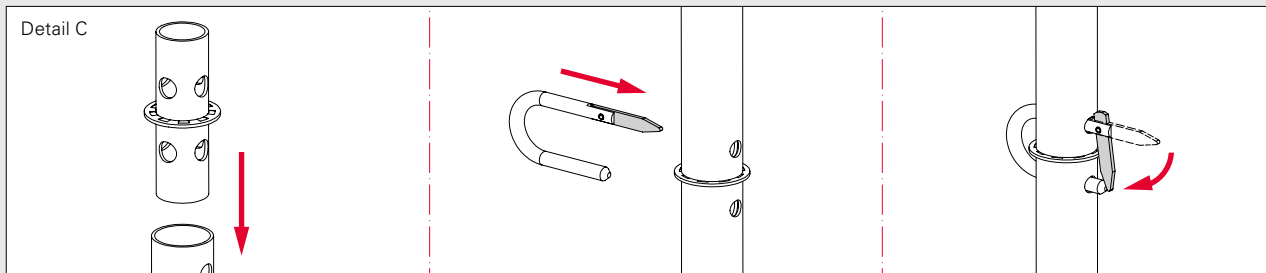

Quick assembly

Assembly of head areas

Assembly of the head area with slab formwork

After reaching the required assembly height, head spindles are installed (see Detail D).

The standard configuration consists of the crosshead spindle, which serves as a support for up to two GT 24 or VT 20 formwork girders.

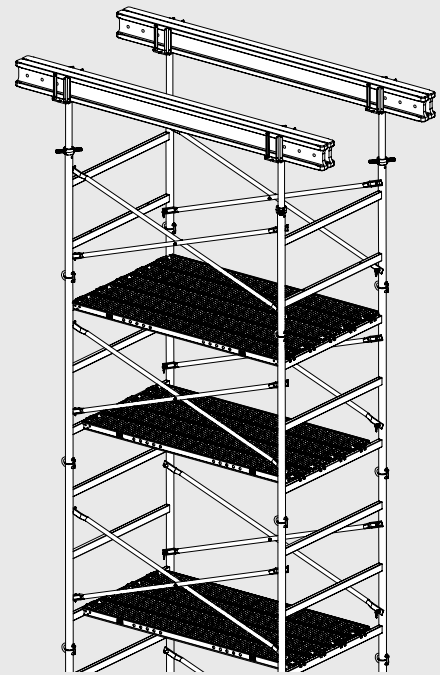
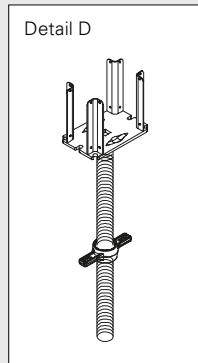

Assembly of the head area with beams in combination with slab formwork

When the beam waler is used, insert PD 5 beam spindles instead of crosshead spindles. To do this, set the beam spindles at the appropriate height and add a crosshead (see Detail E).

Next, set the beam waler between two beam spindles and bring it to the required beam height.

Then secure it with a double pin frame and cotter pins (see Detail F). Mount the corresponding GT 24 or VT 20 girders on the head spindles and the beam waler.

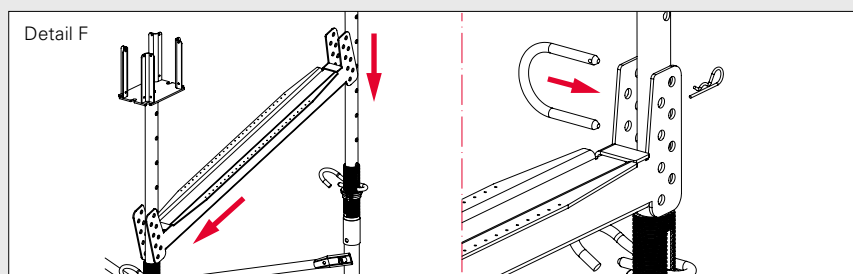
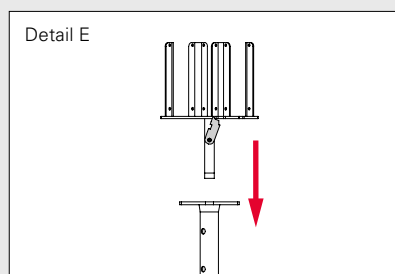
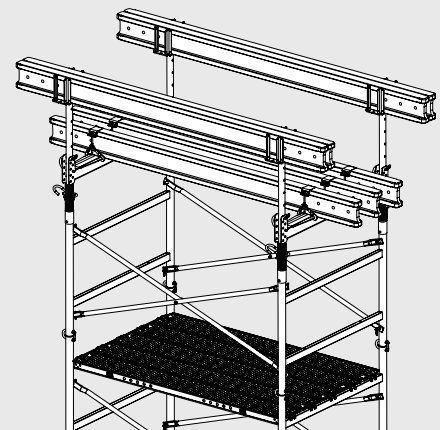



Simple and safe handling

Low component weight and sophisticated frame design

With only six light basic components, numerous applications can be realised simply and safely.

A low weight and sophisticated design of the system components ensures more safety during assembly and dismantling and minimises the level of effort. You can use the system components flexibly alongside decking and ledgers from the PERI UP Flex system construction kit.



The PD 5 Shoring System can be moved horizontally both securely and quickly by crane.

Alternatively, the trolley and winch unit can be used for transport.



The corresponding PERI Instructions for Use should be observed for all moving devices.

PD 5 Shoring System at a glance

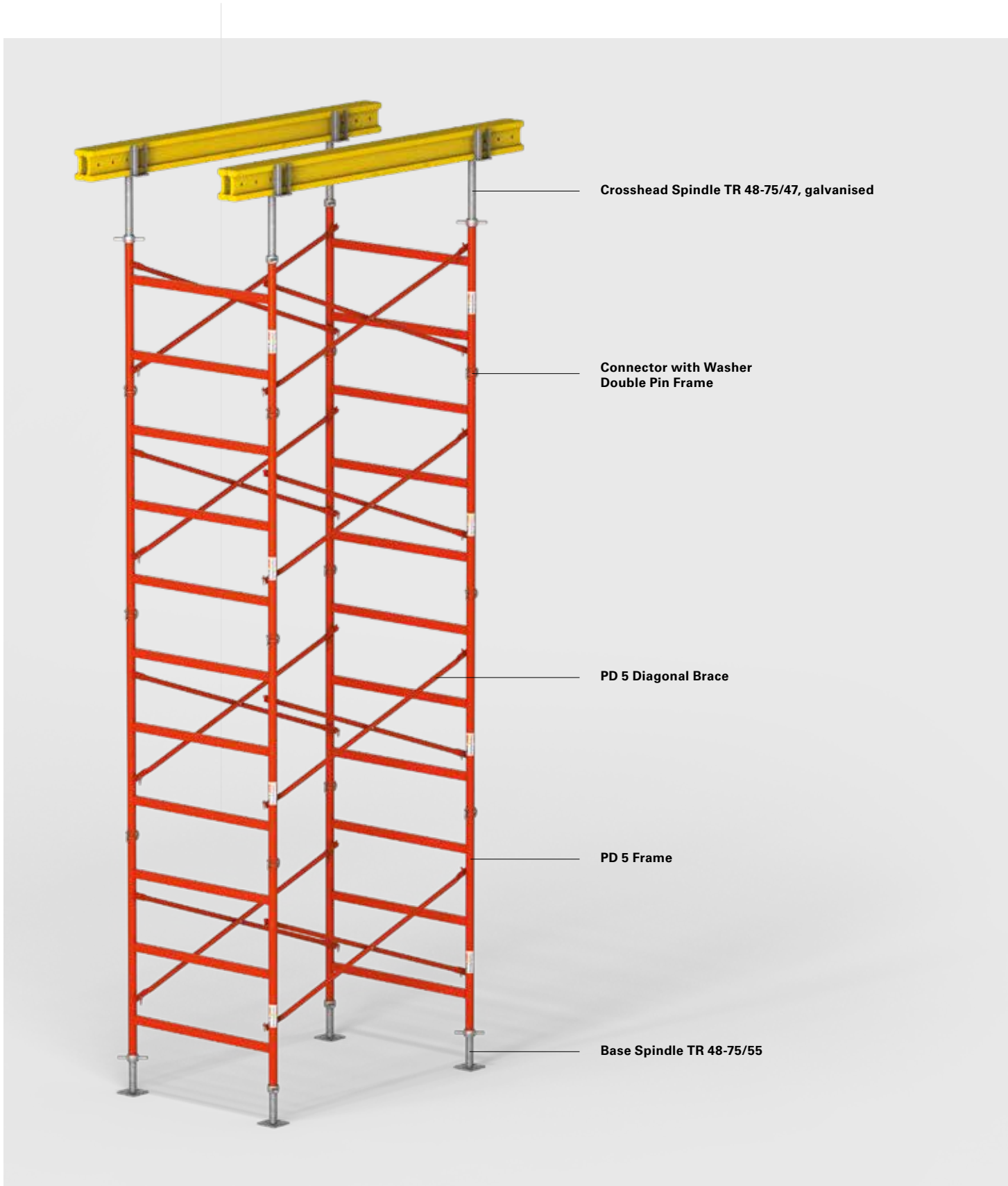

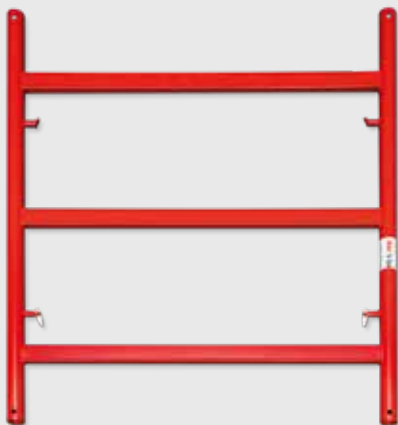

PD 5 Frame



Connector with Washer



Double Pin Frame

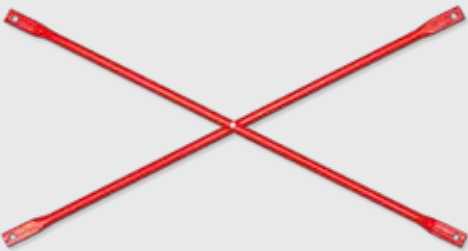

PD 5 Diagonal Brace



**Crosshead Spindle TR 48-75/47,
galvanised**



Base Spindle TR 48-75/55

The PD 5 shoring system consists of a low number of system components.

The main components are:

- PD 5 Frame, available in heights of 100 cm and 150 cm
- Double Pin Frame
- Connector with Washer
- PD 5 Diagonal Braces, available in dimensions of 150 cm, 200 cm and 250 cm
- Cross-head Spindle
- Base Spindle

PD 5 Shoring System in use



500 West Trade, Charlotte, North Carolina, USA

The Charlotte skyline has been redefined by the construction of the 500 West Trade lifestyle destination. The 15-floor luxury residential tower offers a total area of approximately 1,300 m² of everything the heart desires. In addition to a private rooftop bar and a fitness studio with a view over the city, residents will also take advantage of a wellness area and an indoor play area for pets.

The PD 5 shoring system with a height of approximately five metres was used for the erection of the first floor. The PD 5 was an optimum choice for this based on the special on-site circumstances.

The assembly of the shoring on the uneven gravel ground of the site was straightforward, as the system could be adapted almost continuously to the various heights with the crosshead and base spindles.



Kenny Graff, Project Manager

„Compared to the conventional 10K shoring, the PD 5 system is easier to handle and safer, because it is lighter and saves time.“

Total area of approximately 1,300 m²

PD 5 Shoring System with a height of approximately five metres in use for the erection of the first floor

Flexible adaption of the system to various heights

Simple and safe handling of the small number of system components

In addition, the system impressed with the simple handling of the small number of system components. The components are extremely simple and ensure efficient working procedures. Thus, the construction site team could work effectively for hours without tiring. Safety on the construction site was increased as a result.

The customer emphasised that PERI's customer service was an outstanding part of the collaboration. The PERI engineers were available at all times for any questions.

**The optimal System
for every Project and
every Requirement**



Wall Formwork



Column Formwork



Slab Formwork



Climbing Systems



Bridge Formwork



Tunnel Formwork



Shoring Systems



Construction Scaffold



Facade Scaffold



Industrial Scaffold



Access



Protection Scaffold



Safety Systems



**System-Independent
Accessories**



Services



PERI GmbH
Formwork Scaffolding Engineering
 Rudolf-Diesel-Strasse 19
 89264 Weissenhorn
 Germany
 Tel. +49 (0)7309.950-0
 Fax +49 (0)7309.951-0
 info@peri.com
 www.peri.com

