

# PERI UP for Building Construction Projects

## The modular scaffolding kit for versatile use on construction sites

Product Brochure – Issue 08/2018



# Content

## **The PERI UP Construction Kit**

- 4 System Details
- 6 Core Components for a Wide Range of Applications
- 8 Main Component Costs as Share of Total Investment

## **Applications During Construction Phases**

- 10 A Modular Scaffolding Kit for Versatile Use on Construction Sites

## **Construction Site Equipment and Access**

- 12 Construction and Advertising Signs
- 12 Cable and Pipeline Bridges
- 13 Container Access, Scaffolding Access and Staircases
- 13 Trench Bridges

## **Building Shells and Finishing Work**

- 14 Access
- 14 Stairwell Staircases for Access and Finishing
- 15 Reinforcement Scaffolding
- 16 Shoring Towers, Linked Towers and Spatial Shoring
- 16 Shoring Towers, Shoring Towers with Additional Frames
- 17 Heavy-Duty Props
- 17 Project-Specific Solutions Using System and Component Combinations
- 18 Facade Scaffolding for Complex Geometries
- 19 Length-Based Facade Scaffolding
- 20 Weather Protection Roofs

**Issue 08/2018**

### **Publisher**

**PERI GmbH**  
**Formwork Scaffolding Engineering**  
Rudolf-Diesel-Strasse 19  
89264 Weissenhorn  
Germany  
info@peri.com  
www.peri.com

### **Renovation and Refurbishment**

- 22 Working Platforms
- 22 Stairwell Staircases
- 23 Heavy-Duty Props
- 23 Weather Protection Roofs

### **Logistics Accessories for Every Construction Phase**

- 24 Transport Containers

### **Engineering and Services**

- 26 PERI Services for the Very Best Results
- 28 Continuous Support Provided in All Project Phases
- 30 Safety Throughout the Product Life Cycle
- 32 PERI – Your Reliable Partner Worldwide

#### **Important Information**

All current safety regulations and guidelines applicable in those countries where our products are used must be observed.

The photos shown in this brochure feature construction sites in progress. For this reason, safety and anchor details in particular cannot always be considered as conclusive or final. These are subject to the risk assessment carried out by the contractor.

In addition, computer graphics are used, which are to be understood as system representations. To ensure a better understanding, these and the detailed illustrations shown have been partially

reduced to show certain aspects. The safety installations that may not be shown in these illustrations must nevertheless still be available. Please note that the systems or items shown might not be available in every country.

Safety instructions and load specifications are to be strictly observed at all times. Separate structural calculations are required for any deviations from the standard design data.

The information contained herein is subject to technical changes in the interests of progress. Errors and typographical mistakes reserved.

## System Details

**With its metric grid dimensions, the PERI UP scaffolding system has been optimised to ensure a high level of flexibility during use. The rectangular ledgers not only have a static function but also provide support for the decking at any position.**

The main components – standards, ledgers and decking – have a uniform length and width grid arrangement of 25 cm or 50 cm. This grid also continues in a vertical direction in the form of the rosette spacings on the standards.

PERI UP also allows the direction of the decking to be changed during installation, ensuring maximum adaptability to suit project-specific geometries.

This flexibility delivers completely closed working area surfaces and platforms.

With the self-securing deck, ledger with Gravity Lock and the completely flat covering of the working areas, the system provides a very high level of work safety.

Tension-proof connections are used to connect the standards to each other. Thus, complete units can be pre-assembled safely and quickly on the ground and then joined together to form larger scaffold units. Due to the high rigidity of the ledger connections, large-sized scaffold units can also be moved by crane.

In addition with the Easy Frame, the rosette-like shape of the scaffold node is integrated on the frame as a supplementary component.

| Features                        | Your advantages on the jobsite                |
|---------------------------------|---|
| Self-securing ledger connection | Easy assembly                                 |
| Integrated lock against lifting | Fast assembly without any additional handling |
| High node rigidity              | High load-bearing capacity                    |
| Large degree of flexibility     | High degree of material utilisation           |
| Rectangular ledger profile      | Low weight                                    |
| Perforated decking              | Non-slip surfaces                             |

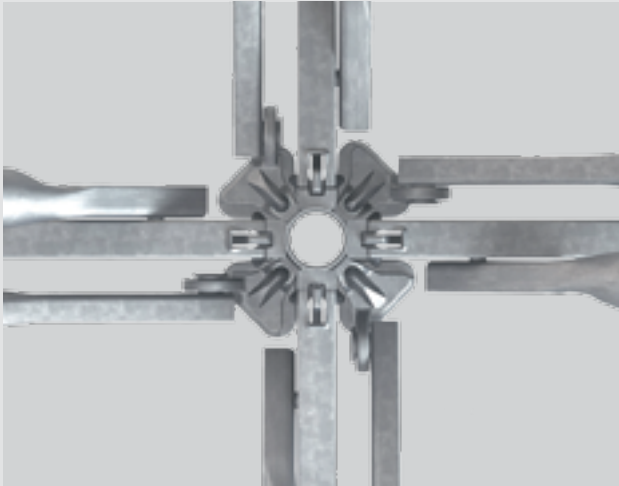

#### **Twelve connection possibilities in the node area**

Four ledgers and node braces respectively can be connected directly to each rosette node. In addition, a further four ledger braces may be connected directly to the ledgers.



#### **Safe ledger assembly**

PERI UP ledgers have a connection in the form of a wedge, which is hooked into the rosette opening. Thereby, the Gravity Lock drops into the rosette opening due to its own weight and is self-locking. This ensures that on-site assembly is easy and safe. The wedge is then secured in position with one blow of a hammer.



#### **Simple decking installation**

The integrated clamp engages the rectangular ledger, securing the position of the decking. PERI UP decks are also secured against lifting after installation without requiring any additional components. Individual scaffold bays can subsequently be removed if required, e.g. for bringing in materials.

# Core Components for a Wide Range of Applications

Weather protection roofs

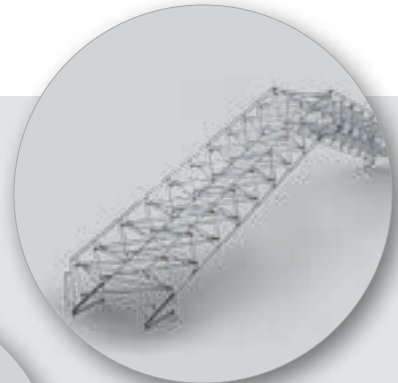

Length-based facade scaffolding



Facade scaffolding for complex ground plans and architecture



Shoring towers, shoring towers with additional frames



Heavy-duty props

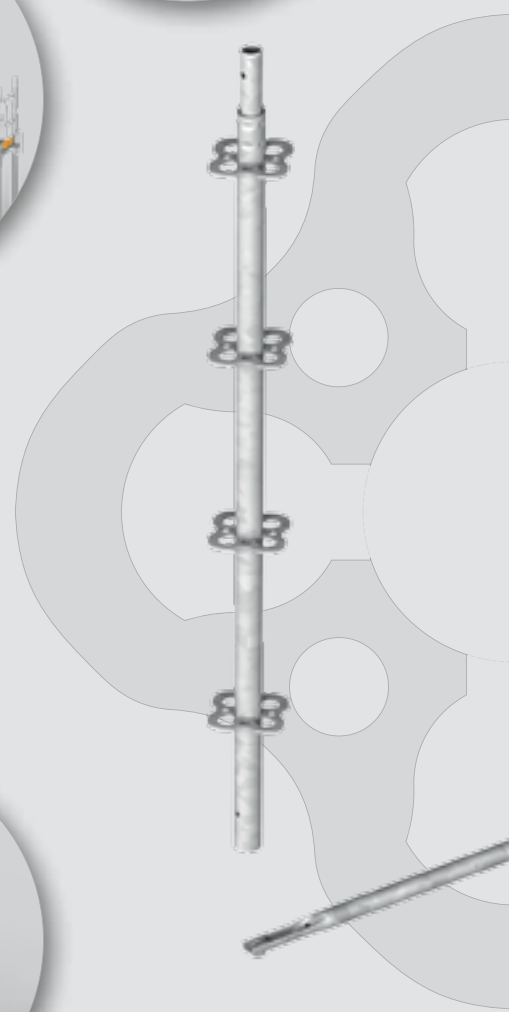
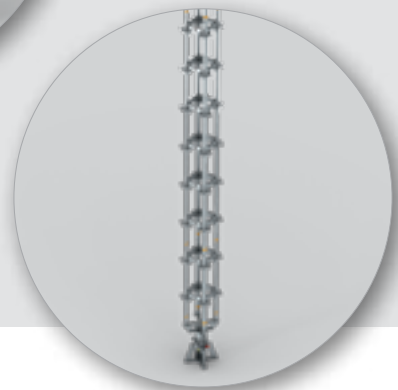



Trench bridges



Staircases, scaffolding access and container access



Reinforcement scaffolding



Access

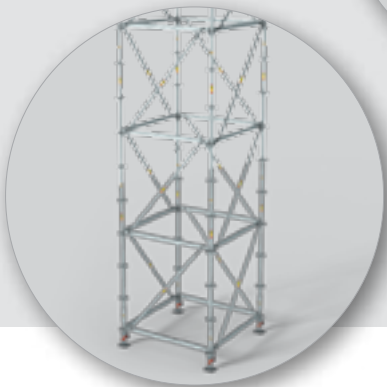

Shoring towers, linked towers and spatial shoring

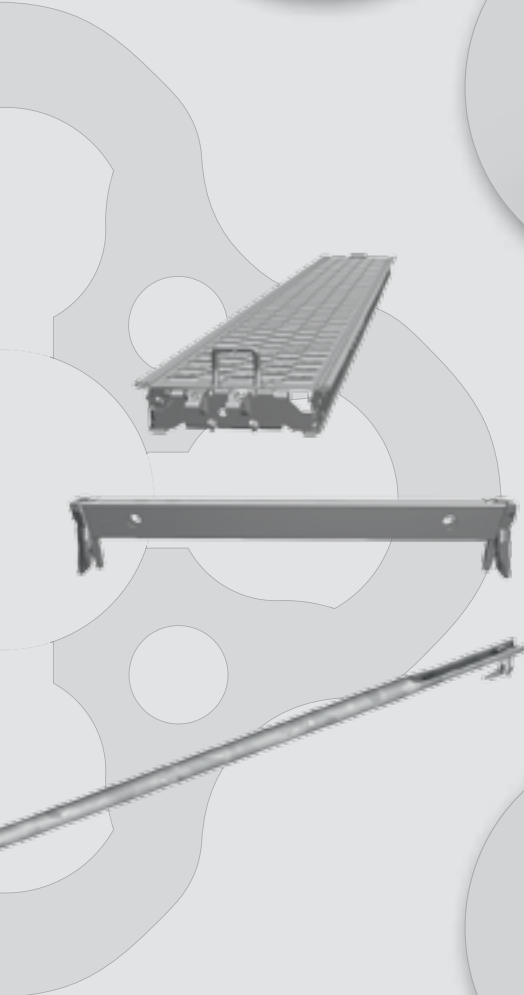

## Main Component Costs as Share of Total Investment

**On the construction site, scaffolding is required for a wide range of applications with various requirements. The spectrum ranges from shoring for transferring area and/or point loads and safe working areas through to convenient access points. The PERI UP modular scaffolding system provides solutions for all areas of application using only a small number of components.**

To provide the optimal solution for this wide range of applications in each case, many scaffold systems feature a large variety of components resulting in very low utilisation rates. The PERI UP scaffolding system, on the other hand, only uses a minimum of components for many applications on the construction site and offers solutions for working scaffolds and shoring, bridging and access means. The high flexibility of the system allows adjustments to be made to suit local conditions while providing the basis for individual, project-specific solutions.

Multiple use of the same system components for different applications increases material utilisation and reduces assembly and investment costs for the scaffolding. Furthermore, the assembly process can be accelerated while facilitating an increase in the quality of the execution through the repetitive working steps. Numerous well-thought-out details add up to cost-effective and safe working with PERI UP.



The Ledger Brace UBL is available in lengths from 100 cm to 300 cm (in 50-cm or 25-cm increments). It is attached using holes in the ledgers.



The lightweight UH Ledger is available in lengths ranging from 25 cm to 400 cm – with 25-cm or 50-cm increments. Use of the strengthened Ledger UHV is recommended for spans of 1.50 m or more.



The 25 cm wide Steel Deck UDG has lengths ranging from 50 cm to 300 cm, likewise with 25-cm or 50-cm increments.



The Standard UVR is available in lengths of 50 cm to 400 cm (in 50-cm or 100-cm increments). The integrated 50-cm rosette spacings match the logical grid dimensions.



**The number of components to be stored, moved and transported is decisive for efficient execution of the scaffolding assembly work, as well as operational cost-effectiveness.**

With the PERI UP Flex modular scaffolding, only a few components are required to realise an extremely diverse range of on-site scaffold operations cost-effectively. The small range of components reduces investment costs and increases utilisation rates.

**Shoring**

PERI UP Flex Shoring Tower

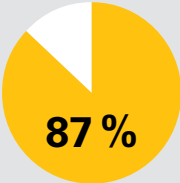
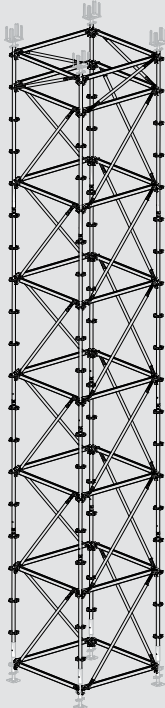

Core component costs as share of the total investment for a height of approx. 10 m and a ground plan of approx. 1.50 m x 1.50 m.

**Reinforcement scaffold**

PERI UP Flex Reinforcement Scaffold

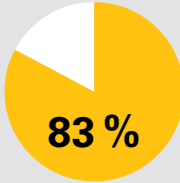
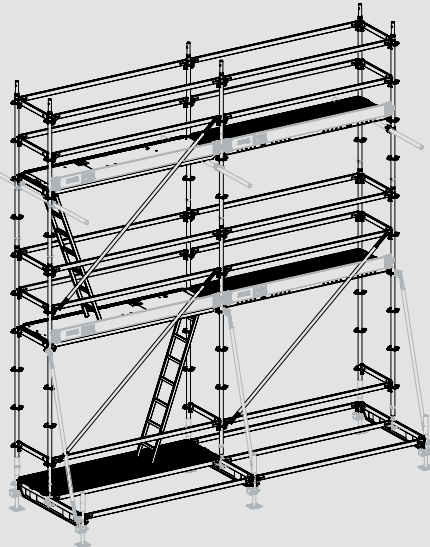

Core component costs as share of the total investment for a standing height of approx. 4.30 m and a base width of 150 m (2 x 250 bays).

**Access**

PERI UP Flex Staircase 100

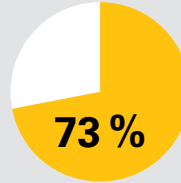
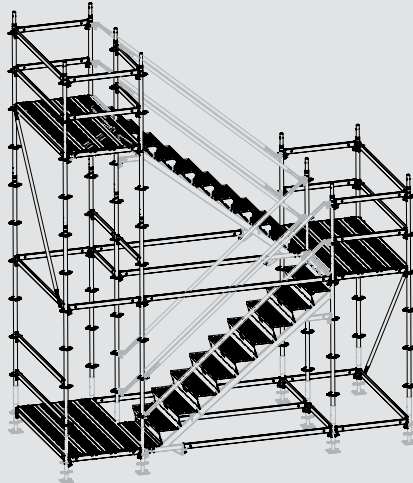

Core component costs as share of the total investment for an access height of approx. 4.30 m and a ground plan of approx. 4.50 m x 2.00 m.

# A Modular Scaffolding Kit for Versatile Use on Construction Sites



**Construction site equipment / access**

**Building shells / finishing work**



Renovation / refurbishment

**The PERI UP Scaffold Construction Kit provides solutions for all areas of application on the jobsite using only a small number of components.**

Multiple use of the same system components for different applications increases material utilisation and reduces assembly and investment costs for the scaffolding.

The following pages feature different application possibilities throughout the construction phases – the spectrum ranges from safe access solutions and working scaffolds through to shoring for transferring area and/or point loads.

## Construction Site Equipment and Access

### Construction and Advertising Signs



#### PERI UP Flex for construction site signs

- Temporary scaffold towers for information and advertising boards
- Can be realised for different geometries and heights
- Can be anchored in ballast bodies by means of pre-stressed steel

### Cable and Pipeline Bridges



#### PERI UP Flex for cable bridges

- For safe and reliable crossing and straddling of access roads when using sensitive pipelines and electric cables
- Span widths can be adapted to match project requirements
- Combination possibilities with formwork components, e.g. Push-Pull Props

## Container Access, Scaffolding Access and Staircases



### PERI UP Flex Staircase 100 / Staircase 125

- Temporary access with 100-cm or 125-cm system widths and separate landings for accommodating high usage by site personnel and convenient transport of materials
- Assembly as a 10-legged stair tower according to the standard configuration with heights up to 50 m for a maximum load of 3.0 kN/m<sup>2</sup>
- Fast assembly with stringers and lightweight individual steps that securely interlock without any additional components
- Closed step profile prevents any material falling through

## Trench Bridges



### PERI UP Flex Trench Bridge

- Temporary, safe crossing means for excavation pits or excavation trenches
- Standard configuration with 6.00-m and 9.00-m spans for a maximum permissible load of 2.00 kN/m<sup>2</sup>
- High level of safety thanks to decking with integrated protection against lifting and non-slip surfaces, as well as toe boards along the walkway.
- Resistant to weather conditions due to timber-free construction
- The 1.00-m width provides comfortable and easy access, also when transporting materials and when site personnel pass each other
- Can easily be moved as a complete unit by crane

## Building Shells and Finishing Work

### Access



#### PERI UP Flex Stairs 75

- Temporary access with a system width of 75 cm to working areas at higher levels or entering construction sites
- Assembly as a 4-legged stair tower according to the standard configuration with alternating staircase units or staircase units in the same direction for heights up to 66 m (or up to 100 m with project-specific planning)
- For a maximum load of 2.0 kN/m<sup>2</sup>
- Assembled using lightweight aluminium flights of stairs which are mounted on ledgers
- Height adjustments accommodated within the system without requiring any time-consuming coupling work



Height adjustments on building openings are carried out independently of the floor heights by means of laterally-mounted brackets and short flights of stairs (1.50 m long, 50 cm/100 cm high).

### Stairwell Staircases for Access and Finishing



#### PERI UP Flex Stairs 75

- Compact access with a width of 75 cm for small staircase wells inside buildings, erected with short PERI UP Flex flights of stairs
- Maximum adaptability to accommodate narrow geometries
- Access to all floors can be created in height increments of 25 cm using standard components
- Standard versions available for common floor heights
- Gap-free, closed scaffold decks due to the 25-cm grid arrangement

## Reinforcement Scaffolding



### PERI UP Flex Reinforcement Scaffold

- Working scaffold with 75-cm or 100-cm decking widths for reinforcement, shuttering and concreting operations (Load Class 1 to 3)
- Execution with a base width of 150 cm or 250 cm and assembly variations with up to 3 bays in a longitudinal direction.
- Maximum standing height 10.80 m, overall length up to 9.00 m in the standard configuration
- Guaranteed stability without ballast or anchoring
- Fast assembly through self-securing ledger connections and integrated protection against lifting in the decks
- High level of safety when working on the formwork thanks to the continuous, gap-free even deck covering
- Large units can be moved by crane due to the very tight connections



## Building Shells and Finishing Work

### Shoring Towers, Linked Towers and Spatial Shoring



#### PERI UP Flex Shoring Tower

- Shoring towers with square or rectangular ground plans with dimensions up to 3.00 m in 50-cm increments
- Can also be used as shoring towers with additional frames
- Enormous degree of adaptability in grid size to suit different geometries and load requirements (e.g. concentrated load transfer by bundling the legs)
- Type-tested: as a free-standing shoring tower with assembly heights up to 8.39 m and for loads up to 40 kN; restrained at the top, up to heights of 21.89 m and loads up to 46 kN
- Fast transportation of large, pre-assembled scaffold units by crane
- Adapted to suit all PERI slab formwork systems

### Shoring Towers, Shoring Towers with Additional Frames



#### PERI UP Flex Shoring Tower MDS K

- Semi-flexible system
- Cost-effective through the use of frames with a width of 125 cm
- Free-standing shoring tower with assembly heights up to 6.39 m and for loads up to 45 kN; restrained at the top, up to heights of 9.39 m and loads up to 50 kN in the standard configuration
- High level of safety during vertical assembly due to the systematic assembly and dismantling of the individual components with protection provided by the guardrail in advance through decking on the inside which is climbed simultaneously
- Reduced misapplications due to the innovative assembly sequence
- Effortless handling due to the low weight of the components (max. 16 kg) and ergonomically advantageous working operations in the centre of the body
- For transferring concentrated loads, up to 2 additional frames can be connected on an individual tower
- Can be moved as a complete unit by crane
- Height adjustment by means of frames in 50-cm grid dimensions



## Heavy-Duty Props



### PERI UP Flex Heavy-Duty Prop HD

- 4-legged heavy-duty prop consisting of lightweight system components for single loads up to 200 kN and an assembly height of up to 8.00 m in the standard configuration
- Displacement and force-controlled pre-stressing and lowering of the prop under load by means of a hydraulic cylinder in the base
- The mobile hydraulic unit can be moved quickly from prop to prop
- Force can be read directly on the manometer for a fast and safe application
- Can be transported and installed manually due to the low weight of individual components (max. 24 kg)

## Project-Specific Solutions Using System and Component Combinations



### Customised solutions with PERI UP Flex, Steel Walers SRU and Climbing Rails RCS

- Optimised use of materials corresponding to the required load capacity due to statically maximised component utilisation
- Flexible adjustment to suit the building geometry
- Cost-effective realisation of supporting structures through the use of standardised, rentable PERI system components and site-compliant connections

## Building Shells and Finishing Work

### Facade Scaffolding for Complex Ground Plans and Architecture



#### PERI UP Flex Facade Scaffold

- Facade scaffolding for cantilevered and demanding forms of architecture
- Particularly high load-bearing 3D scaffold for working on facades (up to Load Class 6)
- Gap-free decking levels, as each bay is completely fitted with system decking and has no tripping hazards
- Decks are directly mounted on the ledgers
- Adjustments take place in uniform 25-cm increments: a high level of flexibility for complex facade scaffolding
- Other system components can be connected using node spacings of 50 cm on the standards
- Roof edge protection and bridging can be assembled using just a few additional components

**With the PERI UP Construction Kit, a high range of applications can be realised using only a minimum number of system components. Rosette nodes are integrated on the vertical system components onto which ledgers, brackets etc. can be directly connected without requiring any couplers. This connection technology is not only fast and safe, but also removes the boundaries between frame and modular scaffolding.**

By featuring identical height dimensions, system components of the PERI UP Easy Frame Scaffolding and PERI UP Flex Modular Scaffolding can be combined at horizontal levels. This results in the creation of a wide range of application options:

- Height compensation
- Accommodating obstacles such as bay windows
- Attaching console brackets in 50-cm height increments
- Attaching material platforms
- Installation of PERI UP Flex Stairs with 75-cm widths

## Length-Based Facade Scaffolding



### PERI UP Easy Facade Scaffolding

- Facade scaffolding for large-area, length-based architecture
- Fall protection without additional components thanks to the systematic assembly procedure with protection provided by the guardrail mounted in advance
- Fast working due to the low weight of the individual components
- Standard configuration with virtually no couplings and with a quick anchoring system
- Fast, well-thought-out solutions for details such as external and internal corners, console brackets etc.
- Combination with PERI UP Flex system components using node connections on the Easy Frame

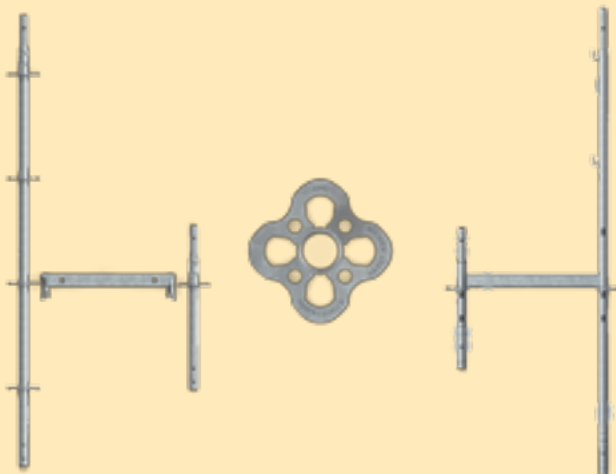

PERI UP Flex

PERI UP Easy

Rosette nodes are integrated on the standards of the PERI UP Flex Modular Scaffolding as well as on the open frames of the PERI UP Easy Frame Scaffolding. This allows for the components of both systems to be combined.

## Building Shells and Finishing Work

### Weather Protection Roofs

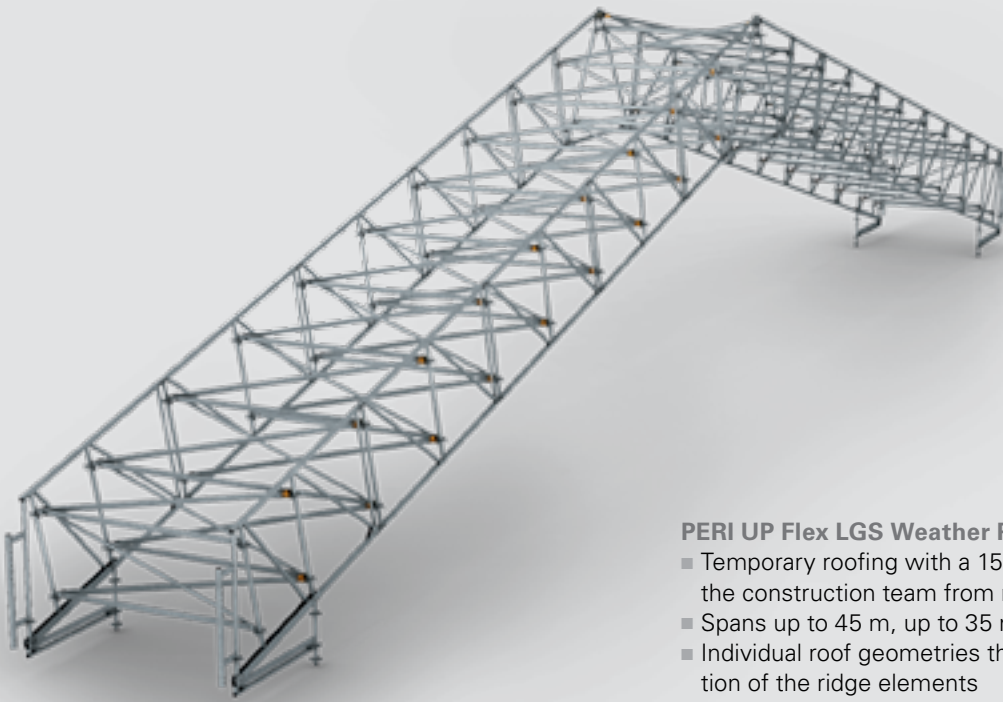

#### PERI UP Flex LGS Weather Protection Roof

- Temporary roofing with a 15° standard roof pitch to protect the construction team from rain, snow or heat
- Spans up to 45 m, up to 35 m without a tension system
- Individual roof geometries through project-specific adaptation of the ridge elements
- Easy and simple opening, closing and moving of the roof elements by hand
- Safe access via walkways along the trusses without the use of any PPE (personal protective equipment against falling)
- Solution with electric motor simplifies the winding and unwinding of the tarpaulins



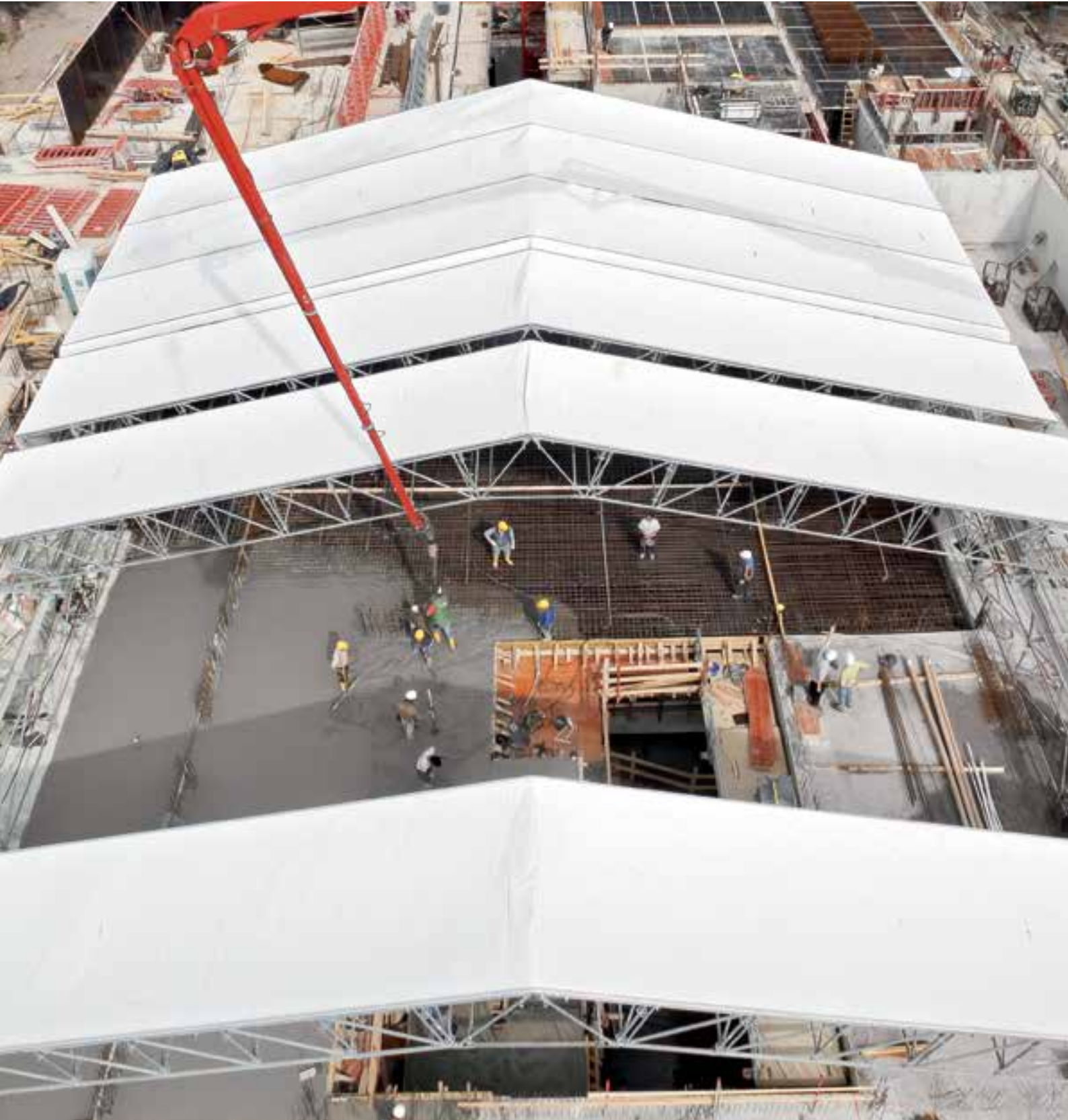

## Renovation and Refurbishment

### Working Platforms



#### PERI UP Flex Working Platforms

- Working platforms ensure safe and productive working on walls and slabs (Load Classes 1 to 6)
- Longitudinal and width adjustments in 50-cm increments
- Tension-proof connection on the standards
- Moving complete platform units with the crane
- Fitted with castors, the platform can also be moved by hand
- Easy height extensions thanks to the modular design principle

### Stairwell Staircases



#### PERI UP Flex Stairs 75

- Compact access with a width of 75 cm for small staircase wells inside buildings, erected with short PERI UP Flex flights of stairs
- Maximum adaptability to accommodate narrow geometries
- Access to all floors can be created in height increments of 25 cm using standard components
- Standard versions available for common floor heights
- Gap-free, closed scaffold decks due to the 25-cm grid arrangement

## Heavy-Duty Props



### PERI UP Flex Heavy-Duty Prop HD

- 4-legged heavy-duty prop consisting of lightweight system components for single loads up to 200 kN and an assembly height of up to 8.00 m in the standard configuration
- Displacement and force-controlled pre-stressing and lowering of the prop under load by means of a hydraulic cylinder in the base
- The mobile hydraulic unit can be moved quickly from prop to prop
- Force can be read directly on the manometer for a fast and safe application
- Can be transported and installed manually due to the low weight of individual components (max. 24 kg)

## Weather Protection Roofs



### PERI UP Flex LGS Weather Protection Roof

- Temporary roofing with a 15° standard roof pitch to protect the construction team from rain, snow or heat
- Can also be used for roof refurbishment and building extensions, as well as bridge, motorway or winter construction sites
- Spans up to 45 m, up to 35 m without a tension system
- Individual roof geometries through project-specific adaptation of the ridge elements
- Easy and simple opening, closing and moving of the roof elements by hand
- Safe access via walkways along the trusses without the use of any PPE (personal protective equipment against falling)
- Solution with electric motor simplifies the winding and unwinding of the tarpaulins

## Logistics Accessories for Every Construction Phase





## Transport Containers

PERI offers reusable transport containers for fast, safe and cost-effective transportation of materials. These include stacking pallets, crate pallets and mesh pallets. All containers provide orderly material storage, space-saving stacking, rapid access to materials and safe transport with a forklift and/or crane.



### Crate pallet

The crate pallet for transporting components that are difficult to stack is available with a painted or galvanised finish. It corresponds to Euro pallet dimensions and can easily be stacked and moved with the crane. A foldable side part facilitates easy storing and removal of components – also if the crate pallet is stacked. The permissible load-bearing capacity is 1.5 t.



### Hardware box

The hardware box is used for storing items that are difficult or impossible to stack. The hardware boxes, which can be stacked together with crate pallets and ring pallets, are available with a galvanised or painted finish. The permissible load-bearing capacity is 1.5 t.

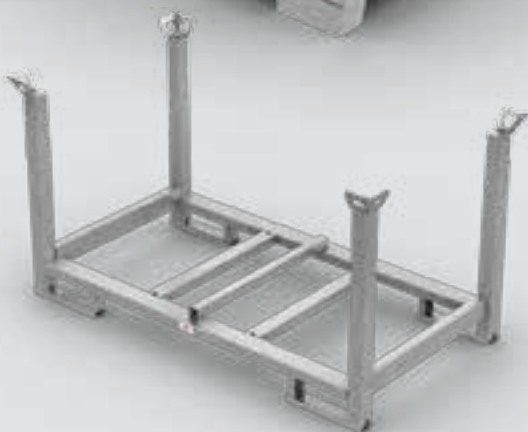

### Pallets

The galvanised pallets are designed for stacking and transporting scaffold components. Up to 4 pallets can be stacked on top of each other. The permissible load-bearing capacity is 1.5 t. As for all PERI pallets and stacking devices, they are suitable for crane and forklift operations, and can be moved with the pallet lifting trolley.

## PERI Services for the Very Best Results





**PERI customers can rely on a comprehensive range of engineering and service solutions.**

The focus of all PERI activities is on having a collaborative partnership with customers and ensuring that we provide cost-effective project solutions - consistent, close cooperation throughout the entire project is a matter of course to us.

# Continuous Support Provided in All Project Phases

Our services and performance are project-specific overall concepts that bring our customers decisive competitive advantages. We also support contractors and site management during the construction phase and continuously throughout the whole project.

The sales engineer is the main point of contact for our customers; he has profound specialist knowledge and under-

stands the precise requirements and needs of the project parties. The extensive network of sales engineers ensures close proximity to users and reliable support.

Requirements are analysed, solution proposals are created and the price-performance ratio is carefully considered - all on a project-related basis. Detailed discussions with the sales

engineers, experts from specialist departments and the site management result in optimised and cost-effective scaffolding solutions.

## Customer requirements

Cost-effectively optimised system equipment for every application

The optimised solution for every scaffolding task

Safe and cost-effective processing

Reliable partner

## The PERI sales engineer

He is the first point of contact for our customers and supports them continuously throughout the project. Depending on the project phase and requirements, he involves the appropriate specialists in the customer service.



## Our service

Intelligently designed products of the best quality

For rationalisation of working procedures and the longest possible service life.

Customer-oriented engineering services

Project-related preparation and planning of the best solution.

Competent logistics and distribution

Fast and flexible deliveries, and permanent support provided throughout the whole project.

Best service for our customers

Our experience and high level of commitment make us a very reliable partner.



Project-specific solutions are developed in a team. The different experiences and approaches of our engineers result in an optimised solution – particularly in terms of cost-effectiveness and safety.

### Project process

Our participation and provision of services begin long before the actual start of the project and go far beyond project completion.

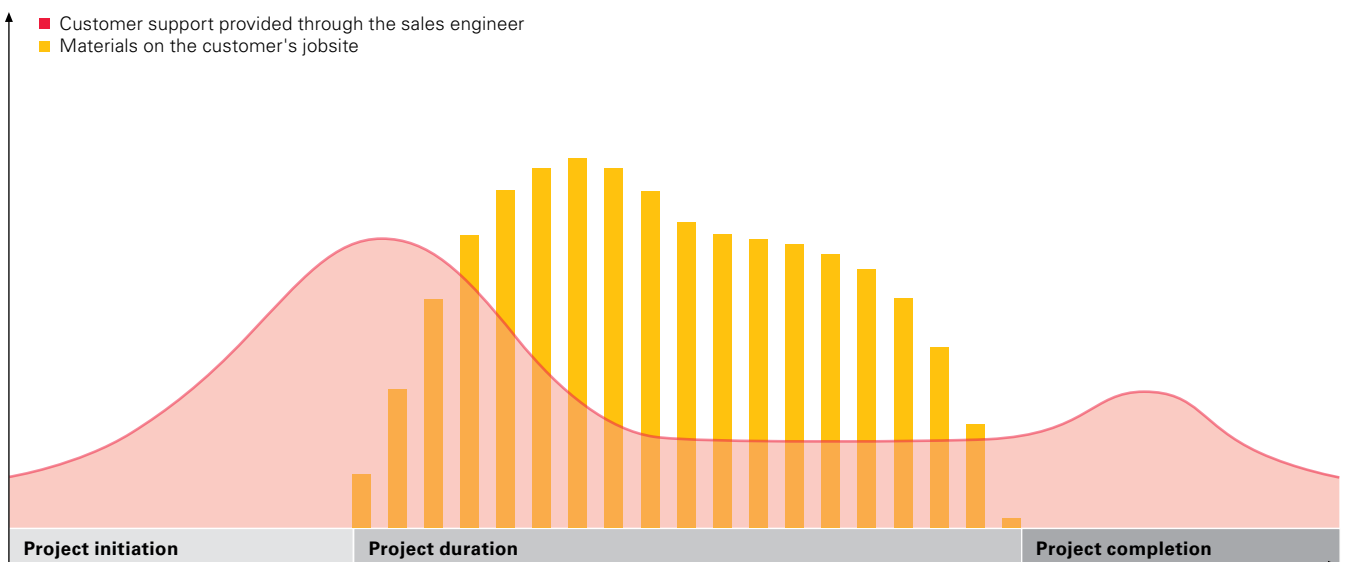

# Safety Throughout the Product Life Cycle

With the PERI UP system technology, PERI has demonstrated that safety does not preclude cost-effectiveness in any way. We follow the principle that the best solution for the customer must always be one of the safest.

At the same time, PERI understands safety in a processual sense, whereby PERI engineering and scaffolding technology is integrated into the customer's project and construction site processes in a timely and targeted manner.

A functioning safety concept covers all aspects of the entire product life cycle. It has to be fully integrated - therefore, we also take into consideration topics such as legal certainty and future viability. Binding offers and clearly regulated criteria for rental and return of materials also offer you security. Many items can also be rented on a project-related basis. Take advantage of our simple work preparation procedure and execution control using our PERI software for scaffolding planning. Standardised parts lists, easy and quick ordering

options and return deliveries allow optimised personnel deployment and material usage.



### High degree of material utilisation

With only one scaffolding system, identical connection logic and a minimum of system components, a wide range of applications can be realised.



### Legal certainty

PERI provides complete and comprehensive documentation, taking into consideration all current standards, requirements and regulations. In addition, this serves as an optimum basis for customer-specific construction site documentation, such as assembly instructions and risk assessment.



### Employee protection

Lightweight individual components for fatigue-free working, integrated user safety and an easily understandable system with design-related logical assembly sequences ensure a high level of employee satisfaction.



### Quality

State-of-the-art production and inspection processes ensure that PERI systems are suitable for tough everyday operations on the jobsite and can be used reliably. The entire process of the serial production that follows is subject to continuous quality assurance.



Smooth construction process: with the latest material technology, approvals and type tests, as well as a comprehensive range of services, PERI makes a significant contribution by supporting the experts on site in carrying out successful construction projects. Risk assessments and assembly instructions can be created easily with the support and documentation provided. Instruc-

tions for Assembly and Use are the basis for a cost-effective and safe working practice. PERI offers a high level of safety during assembly by providing the Instructions for Assembly and Use in different languages. The depictions of individual assembly steps and the complete structure are easy to understand.

## PERI – Your Reliable Partner Worldwide

For more than 45 years, PERI has been a competent provider of formwork and scaffolding systems. Apart from proven and innovative products and systems, PERI also offers a wide range of services that improve and increase the economic efficiency of projects. These include not only individual planning and structural calculations but also, for example, optimised logistical operations and constant support for our customers during construction.

Since the company was founded in 1969, the central functions, development and the main production plant for formwork materials have been located in Weissenhorn, south of Ulm. Since

2016, a new, ultra-modern production facility for the PERI UP scaffolding technology has been operating in the nearby town of Günzburg. Worldwide, over 70 subsidiaries, a large number of branches and more than 140 efficiently-run storage facilities ensure close proximity to our customers and markets.

Market and practice-oriented solutions are realised for all construction projects – whilst always taking the total costs resulting from labour and materials into account - based on our employees' in-depth technical know-how and our extensive knowledge of local requirements.

We know and understand the requirements of our customers intimately, supporting them from the first solution idea to successful conclusion of the project and beyond.

Our maxim is enhanced customer service in all respects. All our employees apply this guiding principle on a day-to-day basis and around the world – they have shaped PERI since the company was founded. This fact, along with our experience from over 45 years of company history and our global activities, benefit each customer and every project – regardless of size.

PERI in Weissenhorn: company headquarters, development and production.







The very latest production facilities, the expertise of the PERI workforce, efficient operational processes and stringent quality tests guarantee the high quality of PERI products and systems.



Product development at PERI is teamwork: practice-oriented scaffolding that is easy and safe to use is created through the collaboration of specialists in the field, development and manufacturing.



Apart from the purchasing option, PERI also offers the possibility of renting formwork and scaffolding systems. In particular, the combination of both models allows cost-effective project realisation.

With over 70 subsidiaries and numerous branch offices, we serve our customers efficiently all over the world.

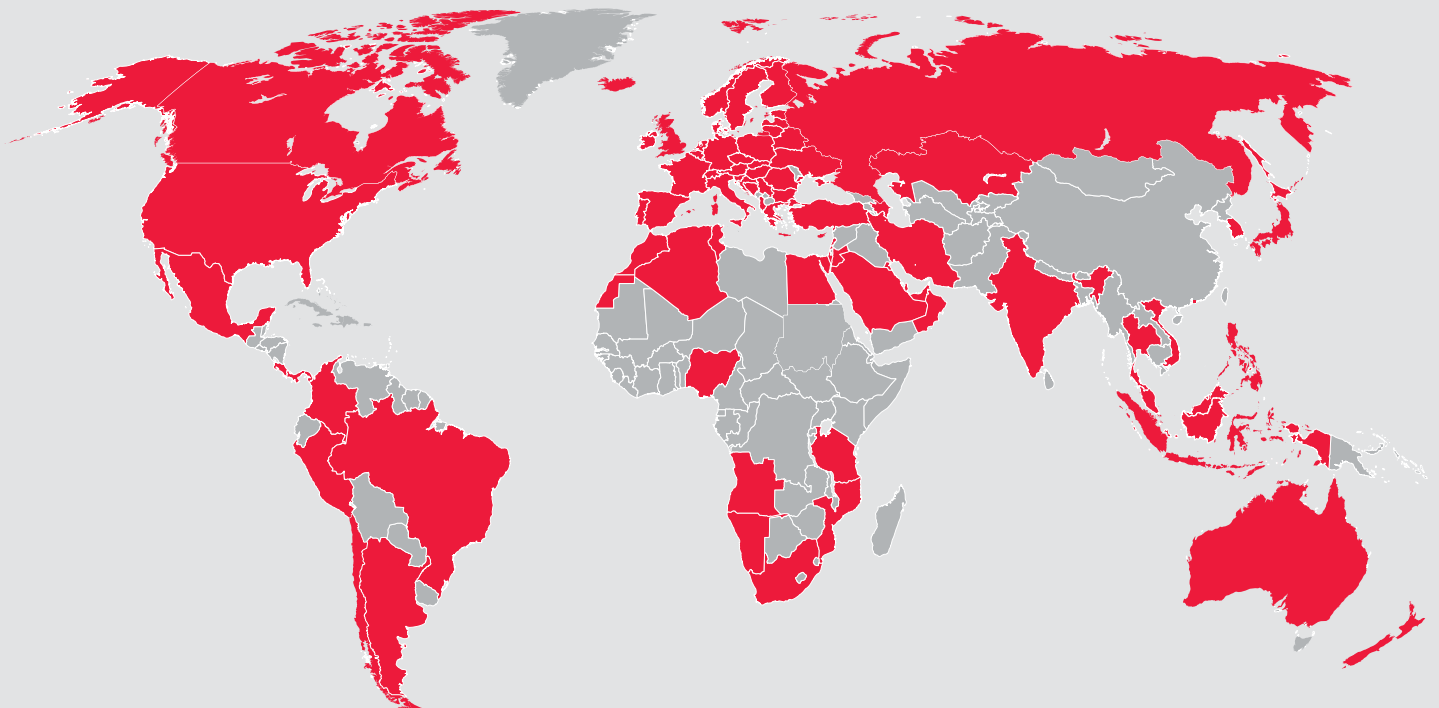

# PERI International

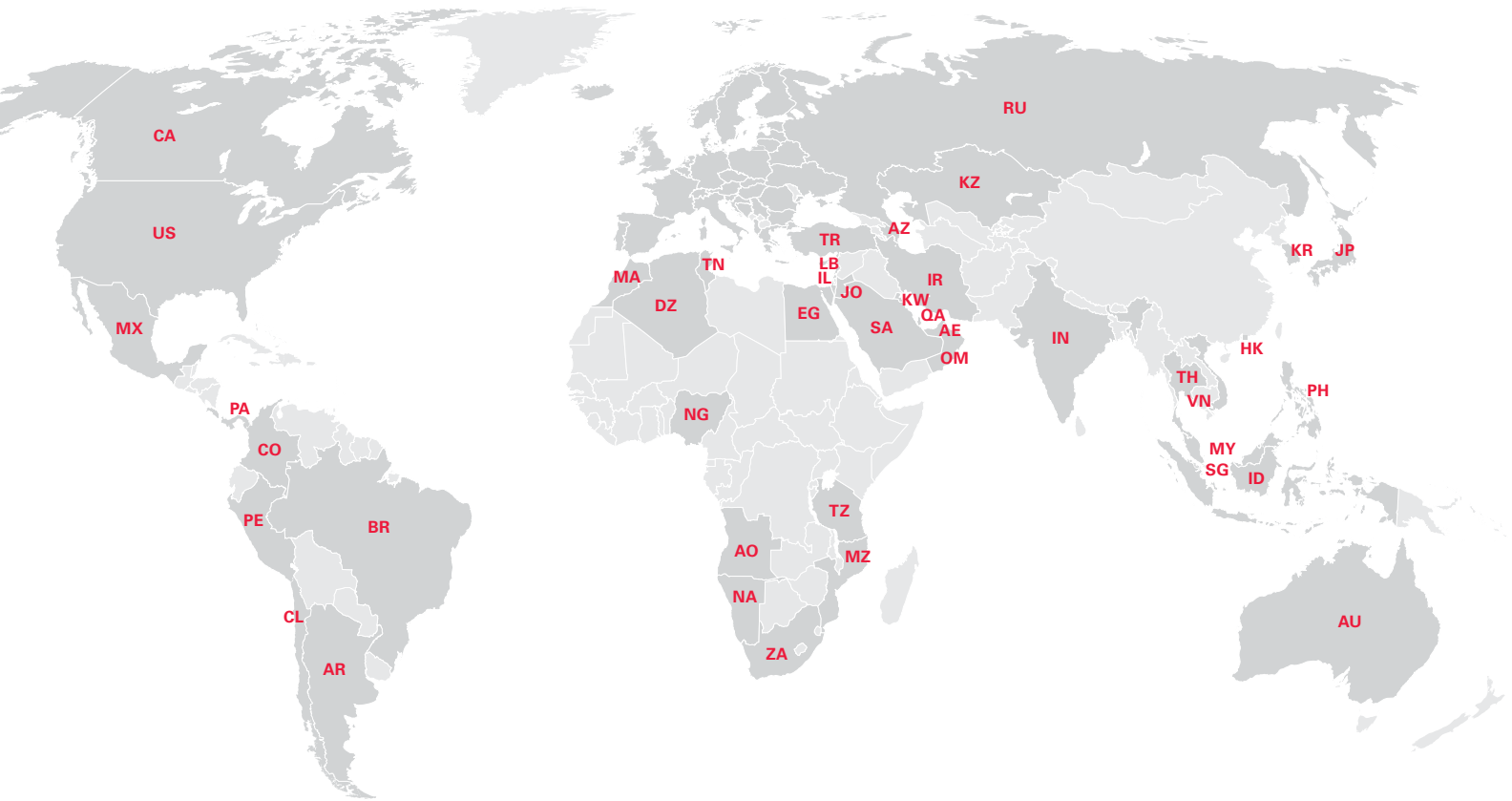

## North America

- CA** Canada  
PERI Formwork Systems, Inc.  
[www.peri.ca](http://www.peri.ca)
- MX** Mexico  
PERI Cimbras y Andamios, S.A. de C.V.  
[www.peri.com.mx](http://www.peri.com.mx)
- PA** Panama  
PERI Panama Inc.  
[www.peri.com.pa](http://www.peri.com.pa)
- US** USA  
PERI Formwork Systems, Inc.  
[www.peri-usa.com](http://www.peri-usa.com)

## South America

- AR** Argentina  
PERI S.A.  
[www.peri.com.ar](http://www.peri.com.ar)
- BR** Brazil  
PERI Formas e Escoramentos Ltda.  
[www.peribrasil.com.br](http://www.peribrasil.com.br)
- CL** Chile  
PERI Chile Ltda.  
[www.peri.cl](http://www.peri.cl)
- CO** Colombia  
PERI S.A.S.  
[www.peri.com.co](http://www.peri.com.co)
- PE** Peru  
PERI Peruana S.A.C.  
[www.peri.com.pe](http://www.peri.com.pe)

## Africa

- AO** Angola  
Pericofragens, Lda.  
[www.peri.pt](http://www.peri.pt)
- DZ** Algeria  
S.A.R.L. PERI  
[www.peri.dz](http://www.peri.dz)
- EG** Egypt  
Egypt Branch Office  
[www.peri.com.eg](http://www.peri.com.eg)
- MA** Morocco  
PERI S.A.  
[www.peri.ma](http://www.peri.ma)
- MZ** Mozambique  
PERI (Pty.) Ltd.  
[www.peri.co.mz](http://www.peri.co.mz)
- NA** Namibia  
PERI (Pty.) Ltd.  
[www.peri.na](http://www.peri.na)
- NG** Nigeria  
PERI Nigeria Ltd.  
[www.peri.ng](http://www.peri.ng)
- TN** Tunisia  
PERI S.A.U.  
[www.peri.es](http://www.peri.es)
- TZ** Tanzania  
PERI Formwork and Scaffolding Ltd  
[www.peri.co.tz](http://www.peri.co.tz)
- ZA** South Africa  
PERI Formwork Scaffolding (Pty) Ltd  
[www.peri.co.za](http://www.peri.co.za)

## Asia

- AE** United Arab Emirates  
PERI (L.L.C.)  
[www.peri.ae](http://www.peri.ae)
- AZ** Azerbaijan  
PERI Representative Office  
[www.peri.com.tr](http://www.peri.com.tr)
- HK** Hong Kong  
PERI (Hong Kong) Limited  
[www.perihk.com](http://www.perihk.com)
- ID** Indonesia  
PT Beton Perkasa Wijaksana  
[www.betonperkasa.com](http://www.betonperkasa.com)
- IL** Israel  
PERI F.E. Ltd.  
[www.peri.co.il](http://www.peri.co.il)
- IN** India  
PERI (India) Pvt Ltd  
[www.peri.in](http://www.peri.in)
- IR** Iran  
PERI Pars. Ltd.  
[www.peri.ir](http://www.peri.ir)
- JO** Jordan  
PERI GmbH – Jordan  
[www.peri.com](http://www.peri.com)
- JP** Japan  
PERI Japan K.K.  
[www.peri.co.jp](http://www.peri.co.jp)
- KR** Korea  
PERI (Korea) Ltd.  
[www.perikorea.com](http://www.perikorea.com)
- KW** Kuwait  
PERI Kuwait W.L.L.  
[www.peri.com.kw](http://www.peri.com.kw)
- KZ** Kazakhstan  
TOO PERI Kazakhstan  
[www.peri.kz](http://www.peri.kz)
- LB** Lebanon  
PERI Lebanon Sarl  
[lebanon@peri.de](mailto:lebanon@peri.de)
- MY** Malaysia  
PERI Formwork Malaysia Sdn. Bhd.  
[www.perimalaysia.com](http://www.perimalaysia.com)
- OM** Oman  
PERI (L.L.C.)  
[www.peri.ae](http://www.peri.ae)
- PH** Philippines  
PERI-Asia Philippines, INC.  
[www.peri.com.ph](http://www.peri.com.ph)
- QA** Qatar  
PERI Qatar LLC  
[www.peri.qa](http://www.peri.qa)
- SA** Saudi Arabia  
PERI Saudi Arabia Ltd.  
[www.peri.com.sa](http://www.peri.com.sa)
- SG** Singapore  
PERI Asia Pte Ltd  
[www.periasia.com](http://www.periasia.com)
- TH** Thailand  
Peri (Thailand) Co., Ltd.  
[www.peri.co.th](http://www.peri.co.th)
- TR** Turkey  
PERI Kalıp ve İskeleleri  
[www.peri.com.tr](http://www.peri.com.tr)
- VN** Vietnam  
PERI ASIA PTE LTD  
[www.peri.com.vn](http://www.peri.com.vn)



# PERI

## PERI GmbH Formwork Scaffolding Engineering

Rudolf-Diesel-Strasse 19  
89264 Weissenhorn  
Germany  
Tel. +49 (0)7309.950-0  
Fax +49 (0)7309.951-0  
info@peri.com  
www.peri.com

## Oceania

**AU** Australia  
PERI Australia Pty. Ltd.  
www.periaus.com.au

**DK** Denmark  
PERI Danmark A/S  
www.peri.dk

**IT** Italy  
PERI S.r.l.  
www.peri.it

**SE** Sweden  
PERI Sverige AB  
www.peri.se

## Europe

**EE** Estonia  
PERI AS  
www.peri.ee

**LT** Lithuania  
PERI UAB  
www.peri.lt

**SI** Slovenia  
PERI oplate i skele d.o.o  
www.peri.com.hr

**AL** Albania  
PERI Kalıp ve İskeleleri  
www.peri.com.tr

**ES** Spain  
PERI S.A.U.  
www.peri.es

**LU** Luxembourg  
N.V. PERI S.A.  
www.peri.lu

**SK** Slovakia  
PERI spol. s. r.o.  
www.peri.sk

**AT** Austria  
PERI Ges.mbh  
www.peri.at

**FI** Finland  
PERI Suomi Ltd. Oy  
www.perisuomi.fi

**LV** Latvia  
PERI SIA  
www.peri-latvija.lv

**UA** Ukraine  
TOW PERI  
www.peri.ua

**BA** Bosnia and Herzegovina  
PERI oplate i skele d.o.o  
www.peri.com.hr

**FR** France  
PERI S.A.S.  
www.peri.fr

**NL** Netherlands  
PERI b.v.  
www.peri.nl

**BE** Belgium  
PERI N.V.  
www.peri.be

**GB** United Kingdom  
PERI Ltd.  
www.peri.ltd.uk

**NO** Norway  
PERI Norge AS  
www.peri.no

**BG** Bulgaria  
PERI Bulgaria EOOD  
www.peri.bg

**GR** Greece  
PERI Hellas Ltd.  
www.perihellas.gr

**PL** Poland  
PERI Polska Sp. z o.o.  
www.peri.com.pl

**BY** Belorussia  
IOOO PERI  
www.peri.by

**HR** Croatia  
PERI oplate i skele d.o.o.  
www.peri.com.hr

**PT** Portugal  
Pericofragens Lda.  
www.peri.pt

**CH** Switzerland  
PERI AG  
www.peri.ch

**HU** Hungary  
PERI Kft.  
www.peri.hu

**RO** Romania  
PERI România SRL  
www.peri.ro

**CZ** Czech Republic  
PERI spol. s r.o.  
www.peri.cz

**IR** Ireland  
Siteserv Access & Formwork  
www.siteservaccess.ie

**RS** Serbia  
PERI oplate d.o.o.  
www.peri.rs

**DE** Germany  
PERI GmbH  
www.peri.de

**IS** Iceland  
Armar ehf.  
www.armor.is

**RU** Russia  
OOO PERI  
www.peri.ru

**The optimal System  
for every Project and  
every Requirement**



**Wall Formwork**



**Column Formwork**



**Slab Formwork**



**Climbing Systems**



**Bridge Formwork**



**Tunnel Formwork**



**Shoring Systems**



**Construction Scaffold**



**Facade Scaffold**



**Industrial Scaffold**



**Access**



**Protection Scaffold**



**Safety Systems**



**System-Independent  
Accessories**



**Services**



**PERI GmbH**  
**Formwork Scaffolding Engineering**  
 Rudolf-Diesel-Strasse 19  
 89264 Weissenhorn  
 Germany  
 Tel. +49 (0)7309.950-0  
 Fax +49 (0)7309.951-0  
 info@peri.com  
 www.peri.com

